

Operation

Residential/Light Commercial Generator Sets



Models:

48RCLB/C
60RCLA/B

Controller:

RDC2

⚠ WARNING: This product can expose you to chemicals, including carbon monoxide and benzene, which are known to the State of California to cause cancer and birth defects or other reproductive harm. For more information go to www.P65warnings.ca.gov

Kohler strongly recommends that only factory-authorized dealers install and service the generator.

Product Identification Information

Product identification numbers determine service parts. Record the product identification numbers in the spaces below immediately after unpacking the products so that the numbers are readily available for future reference. Record field-installed kit numbers after installing the kits.

Generator Set Identification Numbers

Record the product identification numbers from the generator set nameplate(s).

Model Designation _____

Specification Number _____

Serial Number: _____

Controller Identification

Record the controller description from the generator set operation manual, spec sheet, or sales invoice.

Controller Description _____

Engine Identification

Record the product identification information from the engine nameplate.

Manufacturer _____

Model Designation _____

Serial Number _____

Accessory Number	Accessory Description

Accessory Number	Accessory Description

Table of Contents

Safety Precautions and Instructions	7
Introduction	13
Service Assistance	15
Section 1. Service Views	17
Section 2. Generator Set Operation	19
2.1 Operating Area	19
2.2 Prestart Checklist	20
2.3 Exercising the Generator Set	21
2.4 Generator Set Operation	22
2.4.1 Local Starting and Stopping	22
2.4.2 Automatic Starting and Stopping	22
2.4.3 Remote Starting and Stopping	22
2.4.4 Engine Start Crank Cycle	22
2.4.5 Engine Cooldown	22
2.4.6 Automatic Operation with Model RXT Transfer Switch	23
2.4.7 Automatic Operation with Other Transfer Switches	23
2.5 Exercise	23
2.5.1 Unloaded Cycle Exercise with Complete System Diagnostics	24
2.5.2 Unloaded Full-Speed Exercise	25
2.5.3 Loaded Full-Speed Exercise (with RXT only)	25
2.5.4 Shutdown During Exercise (Advanced Diagnostic)	25
2.5.5 Power Failure During Exercise	25
2.5.6 Exerciser Reset	25
2.5.7 Setting the Exerciser at Power-up	26
2.5.8 Changing the Exercise Setting	27
2.6 Faults	30
2.6.1 Warnings	30
2.6.2 Shutdowns	30
2.6.3 ATS Communication Errors	30
2.6.4 Resetting the Controller after a Fault Shutdown	31
2.6.5 Status and Notice Messages	35
2.6.6 Event Log	36
2.7 Model RXT Transfer Switch Operation	37
2.7.1 Source Availability	37
2.7.2 ATS Control Sequence of Operation	37
2.7.3 Time Delays	38
2.7.4 ATS Load Control Relay Time Delay	38
Section 3. RDC2 Controller Operation	39
3.1 RDC2 Generator Set/Transfer Switch Controller	39
3.2 Controls and Indicators	39
3.2.1 Controller Keypad	40
3.2.2 LED Indicators	40
3.2.3 LCD Display	41
3.3 Controller Power	41
3.4 Battery Charging	42
3.5 Changing Settings	42
3.6 Controller Menus	43
3.7 Main Menu	44
3.8 Overview Menu	45

3.9	Engine Metering Menu	46
3.10	Generator Metering Menu	47
3.11	Generator Set Information Menu	48
3.12	Genset Run Time Menu	48
3.13	Genset System Menu	49
3.14	ATS Status Menu	51
3.15	ATS Configuration Menu	52
3.16	Date and Time Menu	53
3.17	Networking Information Menus	53
3.17.1	Networking Status Submenu	54
3.17.2	Networking Configuration Submenu (OnCue® Plus Password)	55
3.17.3	RBUS Information Submenu	56
3.17.4	Remote Devices Submenu	57
3.18	Programmable Interface Module (PIM) Menus	58
3.19	Load Control Menus	59
3.20	Event Log	60
Section 4.	Accessories	61
4.1	Introduction	61
4.2	Battery Heaters	61
4.3	Block Heaters	62
4.4	Emergency Stop Kits	63
4.5	Dual Fuel Automatic Changeover Kit with Reset Box	64
4.6	OnCue Plus Generator Management System	64
4.7	Load Management	65
4.8	Programmable Interface Module (PIM)	65
Section 5.	Scheduled maintenance	67
5.1	General Maintenance	67
5.2	Service Schedule	69
5.3	Lubrication System	70
5.3.1	Oil Specifications	70
5.3.2	Oil Check	70
5.3.3	Oil Additions	70
5.3.4	Oil and Filter Change	71
5.4	Air Cleaner	72
5.5	Exhaust System	74
5.6	Cooling System	75
5.6.1	Checking and Filling Coolant	75
5.6.2	Cooling System Inspection	76
5.6.3	Draining Cooling System	76
5.6.4	Flushing and Cleaning	76
5.6.5	Filling Cooling System	77
5.7	Spark Plugs	77
5.8	Battery	79
5.8.1	Checking Electrolyte Level	80
5.8.2	Checking Specific Gravity	80
5.9	Storage Procedure	82
Section 6.	Troubleshooting	83
6.1	Introduction	83
6.2	USB Port	83
6.3	Fault Messages	83

6.4	Circuit Protection	83
6.4.1	Load Circuit Breaker	83
6.4.2	Fuses	83
6.4.3	Controller Internal Circuit Protection	83
6.5	Generator Set Troubleshooting	84
6.6	Controller Troubleshooting	85
Appendix A.	Abbreviations	87

Notes

Safety Precautions and Instructions

IMPORTANT SAFETY INSTRUCTIONS. Electromechanical equipment, including generator sets, transfer switches, switchgear, and accessories, can cause bodily harm and pose life-threatening danger when improperly installed, operated, or maintained. To prevent accidents be aware of potential dangers and act safely. Read and follow all safety precautions and instructions. **SAVE THESE INSTRUCTIONS.**

This manual has several types of safety precautions and instructions: Danger, Warning, Caution, and Notice.



DANGER indicates a hazardous situation which, if not avoided, will result in death or serious injury.



WARNING indicates a hazardous situation which, if not avoided, could result in death or serious injury.





CAUTION indicates a hazardous situation which, if not avoided, could result in minor or moderate injury.

NOTICE

NOTICE is used to address practices not related to physical injury.





Safety decals affixed to the equipment in prominent places alert the operator or service technician to potential hazards and explain how to act safely. The decals are shown throughout this publication to improve operator recognition. Replace missing or damaged decals.

Accidental Starting

 	<p>Accidental starting. Can cause severe injury or death.</p> <p>Disconnect the battery cables before working on the generator set. Remove the negative (-) lead first when disconnecting the battery. Reconnect the negative (-) lead last when reconnecting the battery.</p>
--	--

Disabling the generator set. Accidental starting can cause severe injury or death. Before working on the generator set or equipment connected to the set, disable the generator set as follows: (1) Press the generator set off/reset button to shut down the generator set. (2) Disconnect the power to the battery charger, if equipped. (3) Remove the battery cables, negative (-) lead first. Reconnect the negative (-) lead last when reconnecting the battery. Follow these precautions to prevent the starting of the generator set by the remote start/stop switch.

Battery

 WARNING	Sulfuric acid in batteries. Can cause severe injury or death. Wear protective goggles and clothing. Battery acid may cause blindness and burn skin.
	
 WARNING	Explosion. Can cause severe injury or death. Relays in the battery charger cause arcs or sparks. Locate the battery in a well-ventilated area. Isolate the battery charger from explosive fumes.
	

Battery electrolyte is a diluted sulfuric acid. Battery acid can cause severe injury or death. Battery acid can cause blindness and burn skin. Always wear splashproof safety goggles, rubber gloves, and boots when servicing the battery. Do not open a sealed battery or mutilate the battery case. If battery acid splashes in the eyes or on the skin, immediately flush the affected area for 15 minutes with large quantities of clean water. Seek immediate medical aid in the case of eye contact. Never add acid to a battery after placing the battery in service, as this may result in hazardous spattering of battery acid.

Battery acid cleanup. Battery acid can cause severe injury or death. Battery acid is electrically conductive and corrosive. Add 500 g (1 lb.) of bicarbonate of soda (baking soda) to a container with 4 L (1 gal.) of water and mix the neutralizing solution. Pour the neutralizing solution on the spilled battery acid and continue to add the neutralizing solution to the spilled battery acid until all evidence of a chemical reaction (foaming) has ceased. Flush the resulting liquid with water and dry the area.

Battery gases. Explosion can cause severe injury or death. Battery gases can cause an explosion. Do not smoke or permit flames or sparks to occur near a battery at any time, particularly when it is charging. Do not dispose of a battery in a fire. To prevent burns and sparks that could cause an explosion, avoid touching the battery terminals with tools or other metal objects. Remove all jewelry before servicing the equipment. Discharge static electricity from your body before touching batteries by first touching a grounded metal surface away from the battery. To avoid sparks, do not disturb the battery charger connections while the battery is charging. Always turn the battery charger off before disconnecting the battery connections. Ventilate the compartments containing batteries to prevent accumulation of explosive gases.

Battery short circuits. Explosion can cause severe injury or death. Short circuits can cause bodily injury and/or equipment damage. Disconnect the battery before generator set installation or maintenance. Remove all jewelry before servicing the equipment. Use tools with insulated handles. Remove the negative (-) lead first when disconnecting the battery. Reconnect the negative (-) lead last when reconnecting the battery. Never connect the negative (-) battery cable to the positive (+) connection terminal of the starter solenoid. Do not test the battery condition by shorting the terminals together.

Engine Backfire/Flash Fire



 WARNING	Risk of fire. Can cause severe injury or death.
	Do not smoke or permit flames or sparks near fuels or the fuel system.

Servicing the fuel system. A flash fire can cause severe injury or death. Do not smoke or permit flames or sparks near the carburetor, fuel line, fuel filter, fuel pump, or other potential sources of spilled fuels or fuel vapors. Catch fuels in an approved container when removing the fuel line or carburetor.

Servicing the air cleaner. A sudden backfire can cause severe injury or death. Do not operate the generator set with the air cleaner removed.

Combustible materials. A fire can cause severe injury or death. Generator set engine fuels and fuel vapors are flammable and explosive. Handle these materials carefully to minimize the risk of fire or explosion. Equip the compartment or nearby area with a fully charged fire extinguisher. Select a fire extinguisher rated ABC or BC for electrical fires or as recommended by the local fire code or an authorized agency. Train all personnel on fire extinguisher operation and fire prevention procedures.

Exhaust System

 WARNING	Carbon Monoxide. Can cause severe nausea, fainting, or death.
	DO NOT locate the generator set near patios, decks, play areas, or animal shelters.

Generator set operation. Carbon monoxide can cause severe nausea, fainting, or death. Carbon monoxide is an odorless, colorless, tasteless, nonirritating gas that can cause death if inhaled for even a short time. Avoid breathing exhaust fumes when working on or near the generator set. Never operate the generator set inside a building unless the exhaust gas is piped safely outside. Never operate the generator set where exhaust gas could accumulate and seep back inside a potentially occupied building.



Carbon monoxide detectors. Carbon monoxide can cause severe nausea, fainting, or death. Install carbon monoxide detectors on each level of any building adjacent to the generator set. Locate the detectors to adequately warn the building's occupants of the presence of carbon monoxide. Keep the detectors operational at all times. Periodically test and replace the carbon monoxide detectors according to the manufacturer's instructions.

Carbon monoxide symptoms. Carbon monoxide can cause severe nausea, fainting, or death. Carbon monoxide is a poisonous gas present in exhaust gases. Carbon monoxide is an odorless, colorless, tasteless, nonirritating gas that can cause death if inhaled for even a short time. Carbon monoxide poisoning symptoms include but are not limited to the following:

- Light-headedness, dizziness
- Physical fatigue, weakness in joints and muscles
- Sleepiness, mental fatigue, inability to concentrate or speak clearly, blurred vision
- Stomachache, vomiting, nausea

If experiencing any of these symptoms and carbon monoxide poisoning is possible, seek fresh air immediately and remain active. Do not sit, lie down, or fall asleep. Alert others to the possibility of carbon monoxide poisoning. Seek medical attention if the condition of affected persons does not improve within minutes of breathing fresh air.

Fuel System

 WARNING	Explosive fuel vapors. Can cause severe injury or death. Use extreme care when handling, storing, and using fuels.
 	

The fuel system. Explosive fuel vapors can cause severe injury or death. Vaporized fuels are highly explosive. Use extreme care when handling and storing fuels. Store fuels in a well-ventilated area away from spark-producing equipment and out of the reach of children. Never add fuel to the tank while the engine is running because spilled fuel may ignite on contact with hot parts or from sparks. Do not smoke or permit flames or sparks to occur near sources of spilled fuel or fuel vapors. Keep the fuel lines and connections tight and in good condition. Do not replace flexible fuel lines with rigid lines. Use flexible sections to avoid fuel line breakage caused by vibration. Do not operate the generator set in the presence of fuel leaks, fuel accumulation, or sparks. Repair fuel systems before resuming generator set operation.



Explosive fuel vapors can cause severe injury or death. Take additional precautions when using the following fuels:

Propane (LPG)—Adequate ventilation is mandatory. Because propane is heavier than air, install propane gas detectors low in a room. Inspect the detectors per the manufacturer's instructions.

Natural Gas—Adequate ventilation is mandatory. Because natural gas rises, install natural gas detectors high in a room. Inspect the detectors per the manufacturer's instructions.





Gas fuel leaks. Explosive fuel vapors can cause severe injury or death. Fuel leakage can cause an explosion. Check the LPG vapor or natural gas fuel system for leakage by using a soap and water solution with the fuel system test pressurized to 6–8 ounces per square inch (10–14 inches water column). Do not use a soap solution containing either ammonia or chlorine because both prevent bubble formation. A successful test depends on the ability of the solution to bubble.

Hazardous Noise

 CAUTION	Hazardous noise. Can cause hearing loss. Never operate the generator set without a muffler or with a faulty exhaust system.
	

Engine noise. Hazardous noise can cause hearing loss. Generator sets not equipped with sound enclosures can produce noise levels greater than 105 dBA. Prolonged exposure to noise levels greater than 85 dBA can cause permanent hearing loss. Wear hearing protection when near an operating generator set.

Hazardous Voltage/Moving Parts

 DANGER	Hazardous voltage. Moving parts. Will cause severe injury or death.
	Operate the generator set only when all guards and electrical enclosures are in place.
 WARNING	Hazardous voltage. Backfed to the utility system. Can cause property damage, severe injury, or death.
	If the generator set is used for standby power, install an automatic transfer switch to prevent inadvertent interconnection of standby and normal sources of supply.
 CAUTION	
Welding the generator set. Can cause severe electrical equipment damage. Welding on generator set will cause serious damage to engine electronic controls components. Disconnect all engine electronic control connections before welding.	

Grounding electrical equipment. Hazardous voltage will cause severe injury or death. Electrocutation is possible whenever electricity is present. Ensure you comply with all applicable codes and standards. Electrically ground the generator set and related equipment and electrical circuits. Turn off the main circuit breakers of all power sources before servicing the equipment. Never contact electrical leads or appliances when standing in water or on wet ground because these conditions increase the risk of electrocution.

Disconnecting the electrical load. Hazardous voltage will cause severe injury or death. Disconnect the generator set from the load by turning off the line circuit breaker or by disconnecting the generator set output leads from the transfer switch and heavily taping the ends of the leads. High voltage transferred to the load during testing may cause personal injury and equipment damage. Do not use the safeguard circuit breaker in place of the line circuit breaker. The safeguard circuit breaker does not disconnect the generator set from the load.

Welding on the generator set. Can cause severe electrical equipment damage. Before welding on the generator set perform the following steps: (1) Remove the battery cables, negative (-) lead first. (2) Disconnect all engine electronic control module (ECM) connectors. (3) Disconnect all generator set controller and voltage regulator circuit board connectors. (4) Disconnect the engine battery-charging alternator connections. (5) Attach the weld ground connection close to the weld location.

Connecting the battery and the battery charger. Hazardous voltage will cause severe injury or death. Reconnect the battery correctly, positive to positive and negative to negative, to avoid electrical shock and damage to the battery charger and battery(ies). Have a qualified electrician install the battery(ies).



Short circuits. Hazardous voltage/current will cause severe injury or death. Short circuits can cause bodily injury and/or equipment damage. Do not contact electrical connections with tools or jewelry while making adjustments or repairs. Remove all jewelry before servicing the equipment.

Engine block heater. Hazardous voltage will cause severe injury or death. The engine block heater can cause electrical shock. Remove the engine block heater plug from the electrical outlet before working on the block heater electrical connections.



Electrical backfeed to the utility. Hazardous backfeed voltage can cause severe injury or death. Install a transfer switch in standby power installations to prevent the connection of standby and other sources of power. Electrical backfeed into a utility electrical system can cause severe injury or death to utility personnel working on power lines.



Servicing the generator set when it is operating. Exposed moving parts will cause severe injury or death. Keep hands, feet, hair, clothing, and test leads away from the belts and pulleys when the generator set is running. Replace guards, screens, and covers before operating the generator set.

Heavy Equipment

 WARNING	Unbalanced weight. Improper lifting can cause severe injury or death and equipment damage. Do not use lifting eyes. Lift the generator set using lifting bars inserted through the lifting holes on the skid.
	

Hot Parts

 WARNING	Hot coolant and steam. Can cause severe injury or death. Before removing the pressure cap, stop the generator set and allow it to cool. Then loosen the pressure cap to relieve pressure. Fill system before starting unit.
	

 WARNING	Hot engine and exhaust system. Can cause severe injury or death. Do not work on the generator set until it cools.
	

Servicing the alternator. Hot parts can cause severe injury or death. Avoid touching the alternator field or exciter armature. When shorted, the alternator field and exciter armature become hot enough to cause severe burns.

Servicing the exhaust system. Hot parts can cause severe injury or death. Do not touch hot engine parts. The engine and exhaust system components become extremely hot during operation.

Notice

NOTICE

Canadian installations only. For standby service connect the output of the generator set to a suitably rated transfer switch in accordance with Canadian Electrical Code, Part 1.

NOTICE

Electrostatic discharge damage. Electrostatic discharge (ESD) damages electronic circuit boards. Prevent electrostatic discharge damage by wearing an approved grounding wrist strap when handling electronic circuit boards or integrated circuits. An approved grounding wrist strap provides a high resistance (about 1 megohm), not a direct short, to ground.

This manual provides operation instructions for Model 48RCLB, 48RCLC, 60RCLA, and 60RCLB residential/light commercial generator sets equipped with the RDC2 generator set/transfer switch controller. See Figure 1 for a typical 48 kW liquid-cooled residential generator set.

Kohler strongly recommends that only factory-authorized dealers or technicians install and service the generator.

This generator set is approved for use in stationary applications in locations served by a reliable utility power source. Have the generator set installed by an authorized Kohler dealer or service technician. Refer to the Installation Manual for installation instructions.

Information in this publication represents data available at the time of print. Kohler Co. reserves the right to change this publication and the products represented without notice and without any obligation or liability whatsoever.

Read this manual and carefully follow all procedures and safety precautions to ensure proper equipment operation and to avoid bodily injury. Read and follow the Safety Precautions and Instructions section at the beginning of this manual. Keep this manual with the equipment for future reference.

The equipment maintenance requirements are very important for safe and efficient operation. Inspect the parts often and perform required maintenance at the prescribed intervals. Obtain service from an authorized Kohler dealer or service technician to keep equipment in top condition.



Figure 1 Model 48RCLB Generator Set

Nameplate

Figure 2 shows a typical generator set nameplate. Copy the model, serial, and specification numbers from the nameplate into the spaces provided in the product information section on the inside front cover of this manual. See the section titled: Service Views for the nameplate location

Figure 2 Nameplate, Typical

List of Related Literature

Figure 3 identifies related literature available for the generator sets covered in this manual. Only trained and qualified personnel should install or service the generator set.

Literature Type	Part Number
Specification Sheet, 48RCLB	G4-276
Specification Sheet, 48RCLC	G4-306
Specification Sheet, 60RCLA	G4-277
Specification Sheet, 60RCLB	G4-307
Installation Manual, 48RCLB, 60RCLA	TP-7101
Installation Manual, 48RCLC, 60RCLB	TP-7203
Operation Manual, Engine	TP-7095
Parts Catalog, Engine	TP-6731
Parts Catalog, Generator Set	TP-6812
Accessory Literature	Part Number
Installation Instructions, Block Heaters	TT-1587
Installation Instructions, Load Shed Kit	TT-1609
Installation Instructions, Programmable Interface Module (PIM)	TT-1584
Installation Instructions, Power Relay Modules	TT-1646
User Guide, OnCue® Plus Program	TP-7006
Technical Manual, OnCue® Plus Program	TP-7007
Operation/Installation Manual, RXT ATS	TP-6807
Operation/Installation Manual, RXT ATS*	TP-7193
Operation/Installation Manual, RDT ATS	TP-6345
Operation/Installation Manual, RDT ATS*	TP-7192

* ATSS built after 6/15/21

Figure 3 Related Literature

For professional advice and conscientious service, please contact your nearest Kohler dealer.

- Visit the Kohler Co. website at KOHLERPower.com.
- Look at the labels and decals on your Kohler product or review the appropriate literature or documents included with the product.
- Call toll free in the US and Canada 1-800-544-2444.

Notes

Section 1. Service Views

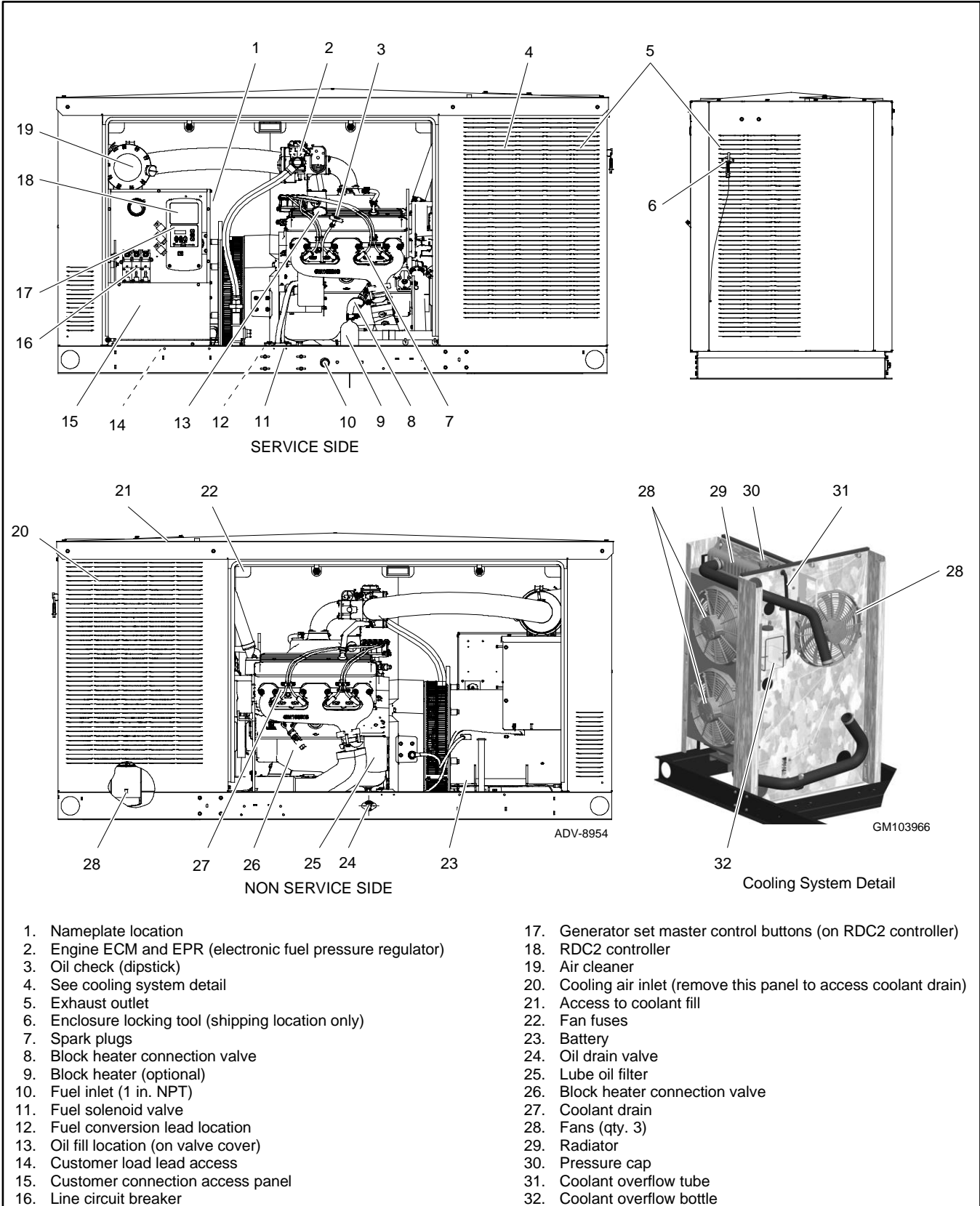

Figure 4 Service Views, 48RCLB and 60RCLA

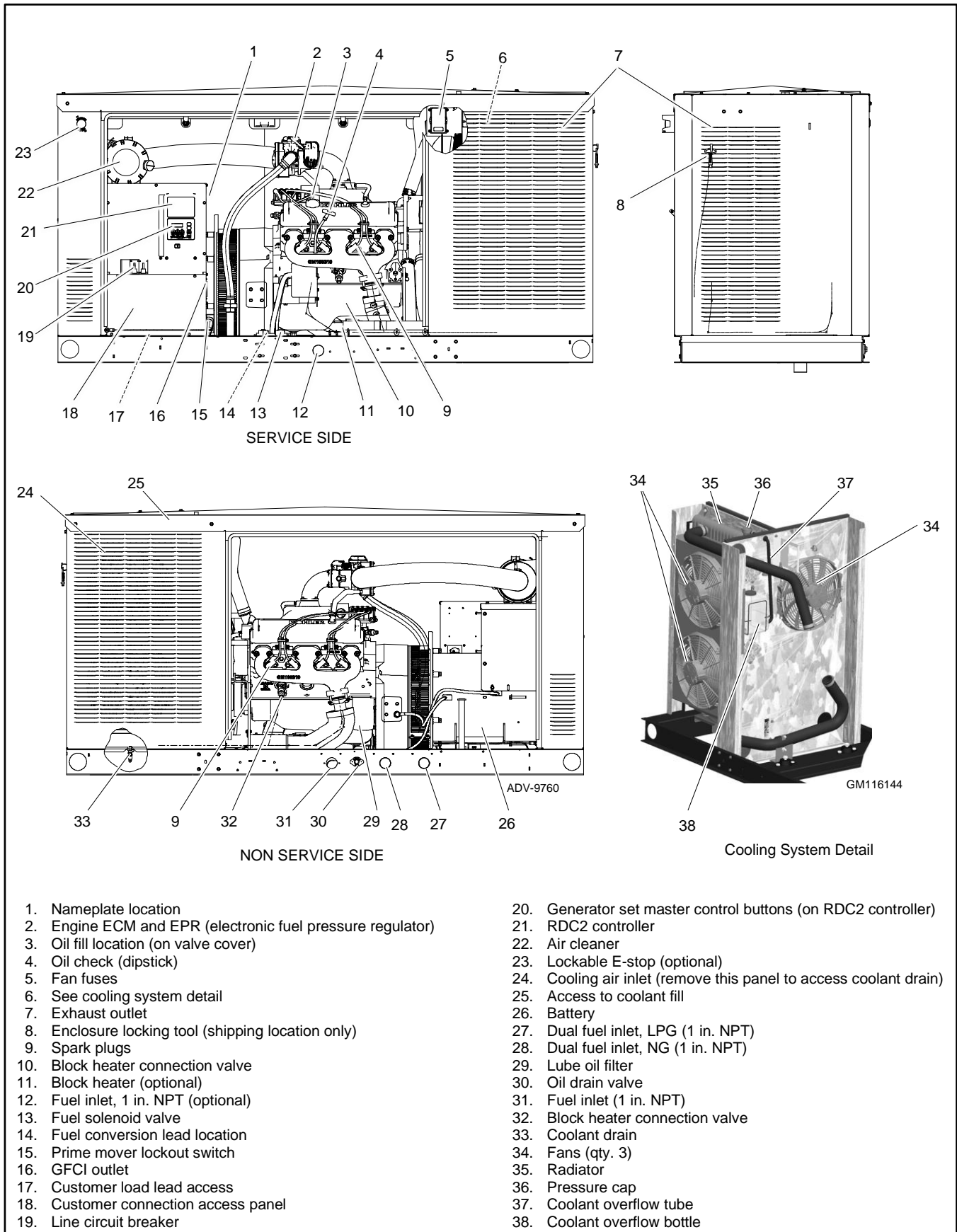



Figure 5 Service Views, 48RCLC and 60RCLB

Section 2. Generator Set Operation

2.1 Operating Area

 WARNING	Carbon Monoxide. Can cause severe nausea, fainting, or death. DO NOT locate the generator set near patios, decks, play areas, or animal shelters.
	

Carbon monoxide symptoms. Carbon monoxide can cause severe nausea, fainting, or death. Carbon monoxide is a poisonous gas present in exhaust gases. Carbon monoxide is an odorless, colorless, tasteless, nonirritating gas that can cause death if inhaled for even a short time. Carbon monoxide poisoning symptoms include but are not limited to the following:

- Light-headedness, dizziness
- Physical fatigue, weakness in joints and muscles
- Sleepiness, mental fatigue, inability to concentrate or speak clearly, blurred vision
- Stomachache, vomiting, nausea

If experiencing any of these symptoms and carbon monoxide poisoning is possible, seek fresh air immediately and remain active. Do not sit, lie down, or fall asleep. Alert others to the possibility of carbon monoxide poisoning. Seek medical attention if the condition of affected persons does not improve within minutes of breathing fresh air.

Generator set operation. Carbon monoxide can cause severe nausea, fainting, or death. Carbon monoxide is an odorless, colorless, tasteless, nonirritating gas that can cause death if inhaled for even a short time. Avoid breathing exhaust fumes when working on or near the generator set. Never operate the generator set inside a building. Never operate the generator set where exhaust gas could seep inside or be drawn into a potentially occupied building through windows, air intake vents, or other openings.

Carbon monoxide detectors. Carbon monoxide can cause severe nausea, fainting, or death. Install carbon monoxide detectors on each level of any building adjacent to the generator set. Locate the detectors to adequately warn the building's occupants of the presence of carbon monoxide. Keep the detectors operational at all times. Periodically test and replace the carbon monoxide detectors according to the manufacturer's instructions.

Keep the generator set area clear. Maintain the required clearance on all sides of the generator set. Verify that there are no windows, air vents, or other openings in the building near the generator set exhaust outlet in any direction. See the generator set dimension drawing in the Installation Manual for required clearance.



Keep the air intake area clean. Do not leave rags, tools, or debris on or near the generator set.

Notice



DO NOT locate patios, decks, play areas, or animal shelters near the generator set. Keep items such as lawn furniture, toys, sports equipment, and all combustible materials away from the generator set exhaust outlet. Remind family members, children, and visitors to use caution near the generator set.



Generator sets connected to automatic transfer switches start automatically during exercise periods and power outages. Some generator set components become hot when the generator set is running and remain hot for a time after the generator set shuts down.

2.2 Prestart Checklist

 WARNING	<p>Accidental starting. Can cause severe injury or death.</p> <p>Disconnect the battery cables before working on the generator set. Remove the negative (–) lead first when disconnecting the battery. Reconnect the negative (–) lead last when reconnecting the battery.</p>
	



Disabling the generator set. Accidental starting can cause severe injury or death. Before working on the generator set or equipment connected to the set, disable the generator set as follows: (1) Press the generator set off/reset button to shut down the generator set. (2) Disconnect the power to the battery charger, if equipped. (3) Remove the battery cables, negative (–) lead first. Reconnect the negative (–) lead last when reconnecting the battery. Follow these precautions to prevent the starting of the generator set by the remote start/stop switch.

 WARNING	<p>Sulfuric acid in batteries. Can cause severe injury or death.</p> <p>Wear protective goggles and clothing. Battery acid may cause blindness and burn skin.</p>
	

 WARNING	<p>Explosion. Can cause severe injury or death. Relays in the battery charger cause arcs or sparks.</p> <p>Locate the battery in a well-ventilated area. Isolate the battery charger from explosive fumes.</p>
	

Battery gases. Explosion can cause severe injury or death. Battery gases can cause an explosion. Do not smoke or permit flames or sparks to occur near a battery at any time, particularly when it is charging. Do not dispose of a battery in a fire. To prevent burns and sparks that could cause an explosion, avoid touching the battery terminals with tools or other metal objects. Remove all jewelry before servicing the equipment. Discharge static electricity from your body before touching batteries by first touching a grounded metal surface away from the battery. To avoid sparks, do not disturb the battery charger connections while the battery is charging. Always turn the battery charger off before disconnecting the battery connections. Ventilate the compartments containing batteries to prevent accumulation of explosive gases.

Battery electrolyte is a diluted sulfuric acid. Battery acid can cause severe injury or death. Battery acid can cause blindness and burn skin. Always wear splashproof safety goggles, rubber gloves, and boots when servicing the battery. Do not open a sealed battery or mutilate the battery case. If battery acid splashes in the eyes or on the skin, immediately flush the affected area for 15 minutes with large quantities of clean water. Seek immediate medical aid in the case of eye contact. Never add acid to a battery after placing the battery in service, as this may result in hazardous spattering of battery acid.

 DANGER	<p>Hazardous voltage. Will cause severe injury or death.</p> <p>This equipment must be installed and serviced by qualified electrical personnel.</p>
	

Grounding electrical equipment. Hazardous voltage will cause severe injury or death. Electrocution is possible whenever electricity is present. Ensure you comply with all applicable codes and standards. Electrically ground the generator set, transfer switch, and related equipment and electrical circuits. Turn off the main circuit breakers of all power sources before servicing the equipment. Never contact electrical leads or appliances when standing in water or on wet ground because these conditions increase the risk of electrocution.

Connecting the battery and the battery charger. Hazardous voltage will cause severe injury or death. Reconnect the battery correctly, positive to positive and negative to negative, to avoid electrical shock and damage to the battery charger and battery(ies). Have a qualified electrician install the battery(ies).

Short circuits. Hazardous voltage/current will cause severe injury or death. Short circuits can cause bodily injury and/or equipment damage. Do not contact electrical connections with tools or jewelry while making adjustments or repairs. Remove all jewelry before servicing the equipment.

To ensure continued satisfactory operation perform the following checks or inspections before or at each startup, as designated, and at the intervals specified in the service schedule. In addition, some checks require verification after the unit starts.

Air Cleaner. Check for a clean and installed air cleaner element to prevent unfiltered air from entering the engine.

Air Inlets. Check for obstructions that could block the flow of cooling air. Keep the air intake area clean. Do not leave rags, tools, or debris on or near the generator set.

Battery. Check for tight battery connections. Consult the battery manufacturer's instructions regarding battery care and maintenance.

Coolant Level. Check the coolant level according to the cooling system maintenance information.

Note:

Block heater damage. The block heater will fail if the energized heater element is not immersed in coolant. Fill the cooling system before turning on the block heater. Run the engine until it is warm, and refill the radiator to purge the air from the system before energizing the block heater.

Drive Belt. Check the belt condition of the water pump and battery charging alternator belt(s).

Exhaust System. Check for exhaust leaks and blockages. Check the silencer and piping condition and check for tight exhaust system connections.

Inspect the exhaust system components for cracks and corrosion (exhaust manifold, exhaust pipe, exhaust clamps, and silencer).

- Check for corroded or broken metal parts and replace them as needed.
- Check that there are no combustible materials near the exhaust outlet.
- Check that the exhaust outlet is unobstructed.

Carbon Monoxide Detectors. Check for the installation and operation of carbon monoxide (CO) detectors on each level of any building near the generator set.

Oil Level. Maintain the oil level at or near, not over, the full mark on the dipstick.

2.3 Exercising the Generator Set

Operate the generator set without load every week or every other week for 20 minutes. Perform all of the prestart checks before starting the exercise procedure. See section titled: Exercise for instructions to set the automatic exerciser.

2.4 Generator Set Operation

2.4.1 Local Starting and Stopping

Start: Press the RUN button to immediately start the generator set.

Stop: Press the OFF button. The engine stops.

Run the generator set with no load for at least 2 minutes to ensure adequate engine cooldown.

2.4.2 Automatic Starting and Stopping

An automatic transfer switch monitors the utility power and signals the generator set to start when utility power is lost. The ATS then transfers the load to the generator set.

When utility power is restored, the transfer switch transfers the load back to utility, runs the generator set with no load to cool down the engine, and then stops the generator set engine. The electric fans continue to run for two minutes after the engine shuts down to evacuate the engine compartment.

2.4.3 Remote Starting and Stopping

A remote switch connected to terminals 3 and 4 can be used to start and stop the generator set. Close the switch to start and run the generator set. Open the switch to stop the generator set.

Run the generator set with no load for at least 2 minutes to ensure adequate engine cooldown.

2.4.4 Engine Start Crank Cycle

The controller attempts to start the generator set three times (three crank cycles, 15 seconds crank and 15 seconds off). If the generator set does not start in three attempts, the system shuts down on an overcrank fault. See section titled: Faults.

Pressing the OFF button during the crank cycle stops the cranking. No other buttons are acknowledged during the crank cycle.

2.4.5 Engine Cooldown

The engine cooldown time delay allows the engine to run after the loads have been removed.

The engine cooldown time delay is set to 5 minutes. The engine stops before the cooldown time delay expires if the temperature drops below the cooled-down temperature level, or if the temperature rises above the high limit during the cooldown cycle.

The electric fans continue to run for two minutes after the engine shuts down to evacuate the engine compartment.

If a transfer switch other than the Model RXT is used, an additional engine cooldown time delay may be programmed on the transfer switch. To allow the smart engine cooldown on the RDC2 controller to operate most efficiently, set the cooldown time on the transfer switch controller to zero or the minimum time allowed. Refer to the instructions provided with the transfer switch for more information.

2.4.6 Automatic Operation with Model RXT Transfer Switch

The Model RXT transfer switch connects to the RDC2 controller through the ATS interface board on the transfer switch. Also see section titled: Model RXT Transfer Switch Operation.

The RDC2 controller must be in AUTO mode for automatic transfer switch operation.

Automatic Start

The RDC2 controller receives utility source voltage sensing data from the Model RXT transfer switch.

1. If the utility source voltage falls below an acceptable level, the controller starts the engine start time delay.
2. If the utility source is not restored before the time delay expires, the generator set starts.
3. After the Normal-to-Emergency time delay, ATS is signaled to transfer the load to emergency source.

Automatic Stop

1. When the utility source is restored, the Emergency to Normal time delay starts.
2. When the Emergency-to-Normal time delay expires, the load is transferred to the utility.
3. The generator set stops.

2.4.7 Automatic Operation with Other Transfer Switches

If a Kohler Model RDT transfer switch is used, the engine start contacts from the ATS must be connected to engine start leads 3 and 4 on the generator set.

The RDC2 generator set controller must be in AUTO mode to respond to remote start/stop signals from an ATS or remote switch. Press the AUTO button on the RDC2 controller to put the generator set into automatic mode.

Automatic Start

The engine start contacts on the ATS close to signal the generator set to start, and remain closed while the generator set is running.

Automatic Stop

The engine start contacts on the ATS open to signal the generator set to stop.

2.5 Exercise

The RDC2 controller can be set to automatically run the generator set at the same time and day every week or every other week. Exercising the generator set every week or every two weeks is required in order to keep the engine and alternator in good operating condition.

Three exercise modes are available: unloaded cycle, unloaded full speed, and loaded full speed. A loaded exercise can be set at the RDC2 controller only if a Model RXT transfer switch is connected. If a Model RDT transfer switch is used, refer to the instructions provided with the transfer switch to set a loaded exercise at the ATS, if desired.

Note:

With the RDT transfer switches, it is possible to have two exercise settings (one unloaded exercise set at the generator set controller, and another exercise set at the ATS controller). If the exercise times overlap, the ATS exercise setting takes priority.

2.5.1 Unloaded Cycle Exercise with Complete System Diagnostics

An unloaded cycle exercise runs the generator set without signalling the transfer switch to transfer the electrical load from the utility source to the generator set. The Unloaded Cycle exercise with diagnostics is the recommended exercise mode and is the factory-default exercise setting.

The Unloaded Cycle exercise runs the engine for 20 minutes in the cycle shown in Figure 6 and described below.

- Runs at reduced speed for 10 minutes to warm up and exercise the engine.
- Ramps up and runs at full speed for 3 minutes. Engine diagnostics are performed during this full-speed portion of the cycle, which provides the best test of engine and alternator power backup capability. Diagnostic tests at full speed can identify potential problems with the power output and alert the operator before an emergency event.
- Ramps down and runs at reduced speed for 5 minutes to cool down the engine before shutting down automatically.

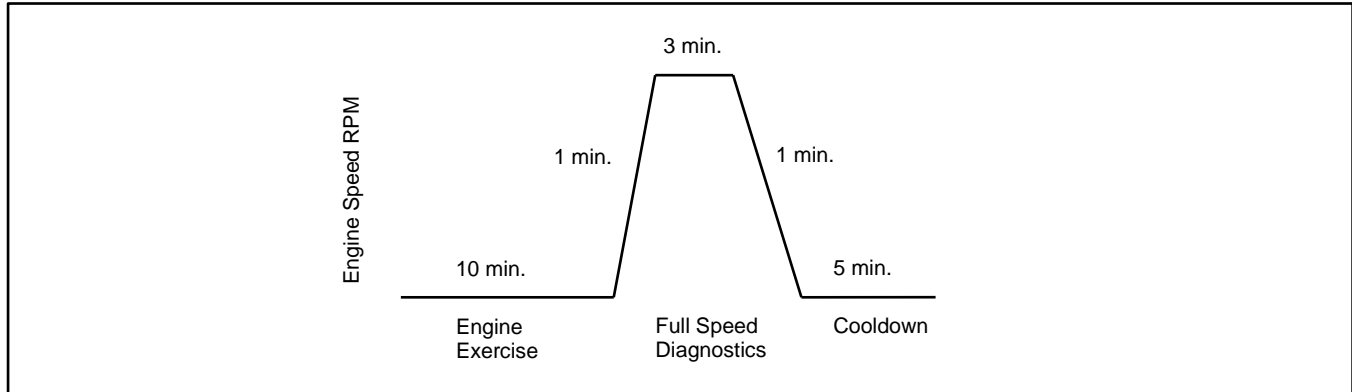

Figure 6 Unloaded Exercise Cycle

System Diagnostics

During the unloaded cycle exercise, the controller monitors the following data. The controller display indicates an unloaded exercise run during the diagnostics, unless a fault is detected as described below.

- **ATS connection.** The controller verifies that the Model RXT ATS interface board is connected.
- **Battery voltage.** Battery voltage is checked before exercise to verify engine starting capability. Battery voltage provides a measurement of battery health. If the controller detects low battery voltage, low battery or low charging battery is displayed and the exercise does not start.
- **Coolant level check.** The coolant level is checked.
- **Communication integrity tests.** J1939, RBUS, Ethernet, and USB are monitored for messages indicating that the controller and wiring are reliable.
- **Engine speed.** Engine speed is measured at low speed and full speed. An overspeed or underspeed condition will result in a fault condition and shutdown.
- **Generator output frequency and voltage.** Operating the generator at full speed allows the RDC2 controller to check the output power for correct voltage, frequency, and stability. When the engine is running at full speed, the controller verifies that the voltage and frequency are within acceptable limits. A fault message is displayed if the voltage or frequency is out of range.
- **Oil pressure.** Oil pressure is verified to ensure proper lubrication of critical engine components. Pressure is monitored at both low and full speeds. If the oil pressure is low, low oil pressure is displayed and the generator set shuts down.

Note:

See section titled: Shutdown During Exercise for information about Advanced Diagnostic Active in the event history.

2.5.2 Unloaded Full-Speed Exercise

The unloaded full speed exercise runs the generator set at full speed for 20 minutes without transferring the load.

To set an unloaded full speed exercise, follow the procedure in figure titled: Procedure to Set the Exerciser and select Exercise Mode: Unloaded Full.

2.5.3 Loaded Full-Speed Exercise (with RXT only)

A loaded exercise starts the generator set, ramps up to full speed, and then transfers the electrical load from the utility source to the generator set. The load is transferred back to the utility source before the generator set shuts down.

Note:

With a loaded exercise, power to the building is lost for up to 10 seconds during load transfer.

For a loaded exercise controlled by the RDC2 controller, a Model RXT transfer switch must be connected to the generator set. To set a loaded exercise, follow the procedure in section titled: Changing the Exercise Setting and select Exercise Type: Loaded.

For a loaded exercise with a transfer switch other than a Kohler® Model RXT, program the exercise at the transfer switch controller. Refer to the transfer switch operation manual for instructions.

2.5.4 Shutdown During Exercise (Advanced Diagnostic)

The following advanced diagnostic operation applies to RDC2 controllers with firmware versions 5.04 and higher.

If the generator set shuts down on a fault during an exercise, the controller will try to restart the engine. If the engine starts, the generator set will run at full speed for two minutes and then stop. The event history will show Advanced Diagnostic Active. The exercise schedule is maintained.

If the engine does not start, the shutdown message will be displayed. Correct the fault condition and reset the fault as described in section titled: Faults.

2.5.5 Power Failure During Exercise

If the utility power is lost during an unloaded exercise, the ATS transfers to the emergency source, the exercise is ended and the control remains in the AUTO mode.

If the utility power is lost during a loaded exercise, the exercise is ended. The ATS remains in the emergency position and the control goes into the AUTO mode.

The generator set continues to run and supply power to the load for the duration of the utility power outage. When Utility power is restored, the ATS will re-transfer to the utility source through normal timing sequences.

2.5.6 Exerciser Reset

To reset the exerciser to run at a different day and/or time or to change the exercise mode, follow the procedure in section titled: Setting the Exerciser at Power-up to change the exerciser settings.

2.5.7 Setting the Exerciser at Power-up

When power is connected to the controller, you will be prompted to select the language and set the date, time, and exercise schedule.

1. At power-up, you will be prompted to select a language for the controller displays. Use the up and down arrow buttons to step through the language options. Press the Select button when the desired language is displayed.
2. Next, the date is displayed with the year flashing. Use the up or down arrow key to step to the current year.
3. Press Select button to save the year and move to the month.
4. Use the arrow and select buttons to set the month and the day.
5. The time is displayed with the hour flashing. Use the up or down arrow key to step to the current hour and am or pm setting.

Note:

Check the am/pm setting displayed. If pm is displayed and you need to change it to am, use the down arrow button to step down in time until the correct hour and am are displayed.

6. Press the Select button to save the hour and move to minutes.
7. Use the up or down arrow button to change the minutes.
8. Press Select to save the time and move to the next screen.
9. Next Exercise is displayed. Use the up, down, and select buttons to set the exercise time and date. Be sure to set a time and date in the future.
10. Press Select. The controller exits the exercise menu.
11. Press the Auto button and verify that the AUTO LED is lit. The generator set must be in automatic mode for the exercise to run as scheduled.

The exercise will run every 7 days at the same time, starting on the date set. To change the exerciser to run every other week or on a different day and time, use the following procedure.

2.5.8 Changing the Exercise Setting

Set the date and time on the controller before setting the exercise schedule. Set the exerciser to automatically run the generator set for 20 minutes every week or every two weeks. Follow the procedure below and see the flowchart in Figure 8 to set the exercise time and date, mode, and frequency.

Procedure to Change the Exercise Setting

1. Press the AUTO button on the controller.
2. Press the Select button to go to the main menu. See Figure 7.
3. Press the down arrow button to step to the Genset System menu.
4. Press the Select button to enter the Genset system menu. See Figure 8.
5. Use the down arrow button to step to the next Exercise menu.
6. Press the Select button. The setting flashes to show that it can be changed. For example, the hour flashes to show that the hour can be changed.
7. Press the UP or Down arrow buttons to change the setting.
8. Press the Select button to save the setting and move to the next. For example, save the hour setting and move to minutes.
9. Repeat steps 5 through 8 to change the next item on the line until the desired settings are displayed.
10. Press Select to save after all settings have been selected. Settings will stop flashing.
11. If the generator set is connected to a Kohler® Model RXT transfer switch, the exercise can be changed to a loaded exercise. Set the Exercise Mode to loaded full speed, unloaded full speed, or unloaded cycle as shown in Figure 8.
12. Set the exercise frequency (weekly or every two weeks). Weekly exercises are recommended.
13. Press the down arrow button to step to the Return menu. Press the Select button to return to the main menu.
14. Check that the AUTO LED is lit. The generator set must be in automatic mode for the exercise to run as scheduled.

After a scheduled exercise run, the next exercise time and date will be updated automatically based on the Exercise Frequency setting.

Other transfer switches: For a loaded exercise with a transfer switch other than a Kohler® Model RXT, program the exercise at the transfer switch controller. Refer to the transfer switch operation manual for instructions.

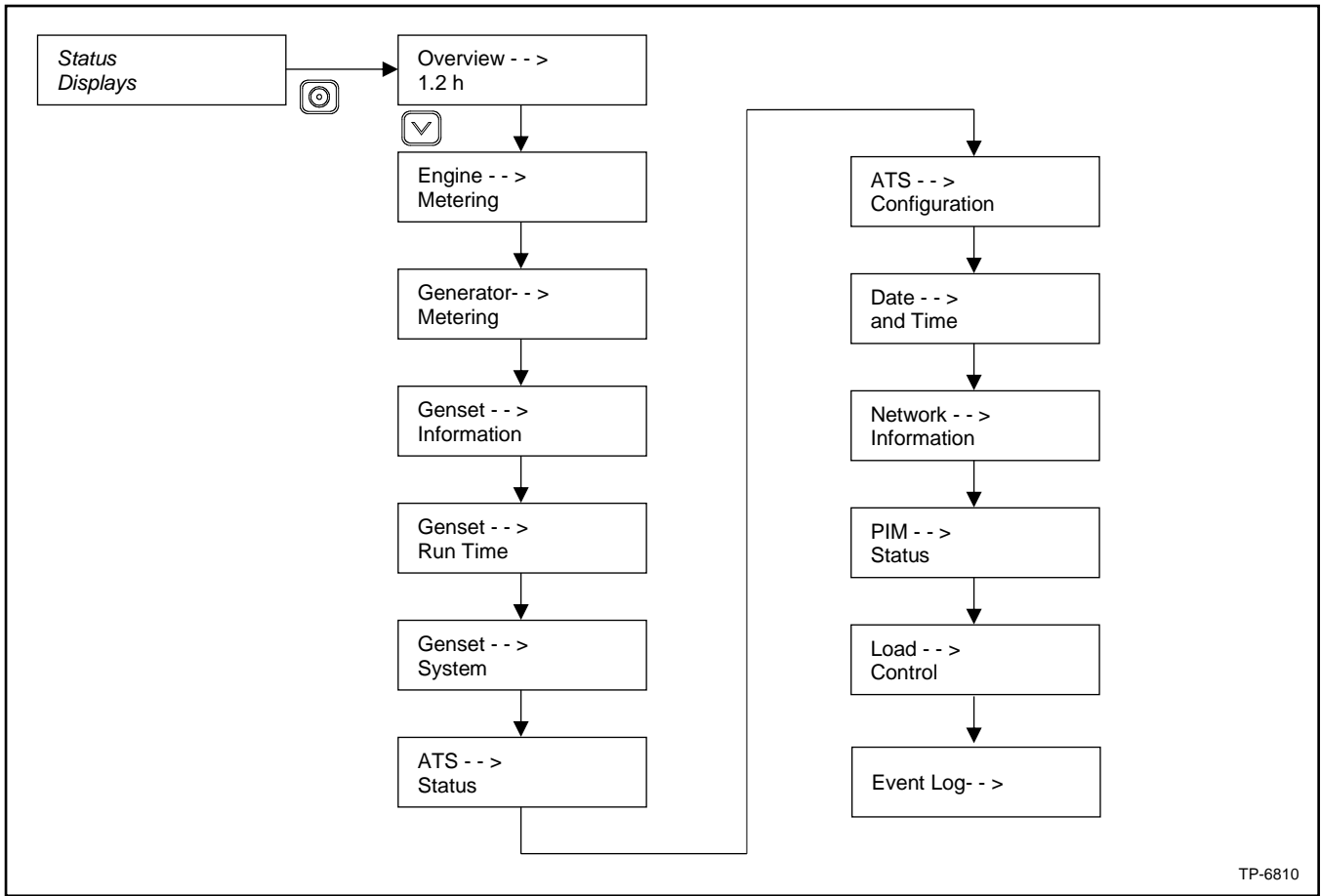

Figure 7 RDC2 Main Menu

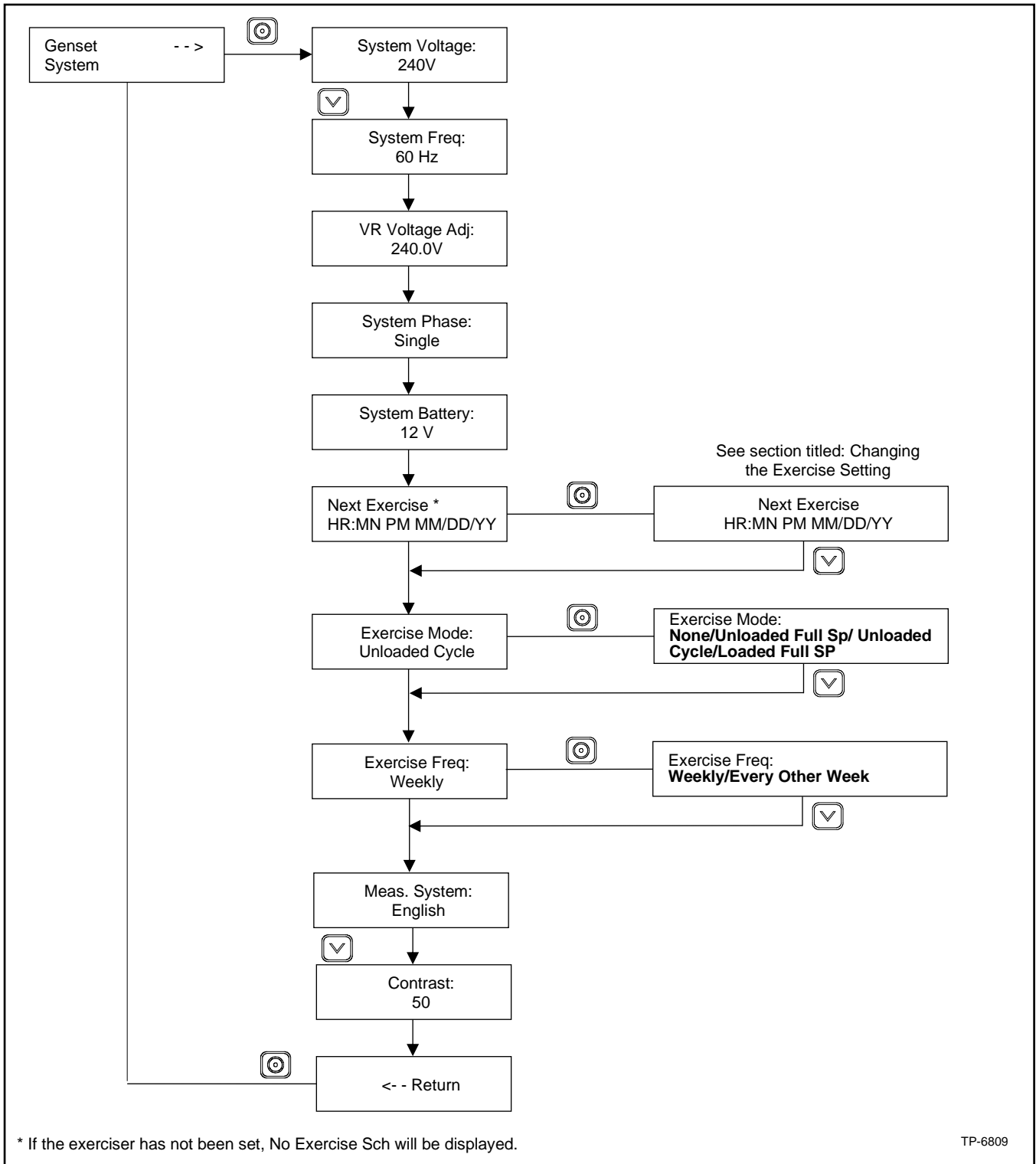

Figure 8 Procedure to Set the Exerciser

2.6 Faults

Selected fault conditions are shown in figure titled: Controller Fault Messages. Fault conditions are classified as warnings or shutdowns. Additional fault messages related to the engine and other messages are possible. If a fault occurs that is not listed in the table, contact an authorized dealer for service.

If a programmable interface module (PIM) is connected to the generator set controller, additional faults can be activated by customer-supplied equipment. See TT-1584, Installation Instructions for the Programmable Interface Module, for available inputs and outputs.

2.6.1 Warnings

The controller displays a fault message but the generator set does not shut down on a warning. The controller resets automatically after a warning condition is corrected.

2.6.2 Shutdowns

Under a fault shutdown condition, the generator set shuts down automatically and the controller displays a fault message. The OFF LED flashes. See figure titled: Controller Fault Messages .

Shutdown switches (such as the low coolant level switch or high engine temperature switch) on the generator set will automatically reset when the problem is corrected. However, the fault condition at the controller does not clear until the controller is reset.

The generator set cannot be restarted until the fault condition is corrected and the controller is reset. See section titled: Resetting the Controller after a Fault Shutdown to reset the controller after a fault shutdown.

2.6.3 ATS Communication Errors

When a Model RXT transfer switch is used, an ATS fault indicates that the connection to the interface board on the transfer switch has been lost. Check the connection to the ATS interface board.

2.6.4 Resetting the Controller after a Fault Shutdown

Always identify and correct the cause of a fault shutdown before resetting the controller. Check the fault message displayed on the controller and refer to Figure 10 to identify and correct the fault condition before proceeding. Contact a Kohler authorized dealer for service, if necessary.

Press the OFF button to reset the controller, or follow the procedure below. See Figure 9

Procedure to Reset the Controller after a Fault Shutdown

1. Press the Select button to go to the Overview menu.
2. Press Select again. The active fault is displayed.
3. Press Select. Confirm Clear Fault: NO is displayed.
4. Press the Up arrow button. Confirm Clear Fault: YES is displayed.
5. Press the Select button to enter YES and clear the fault.
6. Press the Select Button to return to the overview menu.
7. Press AUTO to put the generator set into automatic mode.

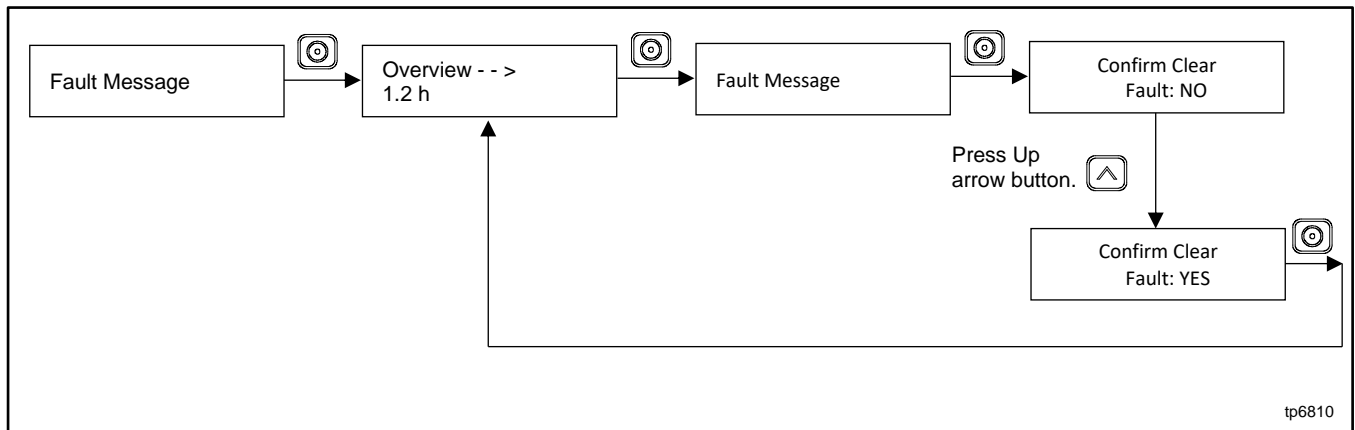

Figure 9 Clearing a Fault

Fault (RDC2)	Fault (OnCue® Plus)	Condition	Check
AC Sens Loss Warning (1 sec.) Shutdwn (3 sec.)	AC Sensing Lost	AC Sensing Lost. In Auto mode, generator output AC sensing is lost. Detection begins 10 seconds after crank disconnect. Warning: after 1 second if no output detected after crank disconnect. Shutdown: after 3 seconds if voltage was present and then lost.	Contact an authorized dealer for service.
Accy PwrOver Warning	Accessory Power Overload	Accessory Power Overload. An over current fault (short circuit) on the accessory controller power output.	Contact an authorized dealer for service.
ATS ComError Warning	ATS Communication Error	ATS Communication Error. Warning is displayed if RXT interface connection is lost.	Contact an authorized dealer for service.
ATS PhaseRot Warning	ATS Phase Rotation Mismatch	ATS Phase Rotation Mismatch. Transfer switch phase rotation does not match. ATS will not transfer.	Contact an authorized dealer for service.
Aux Input Shutdwn	Auxiliary Input	Auxiliary Input. An optional customer- connected input is closed. (Digital input from optional PIM.)	Check customer-supplied equipment.
Battery CrLo Warning	Battery Voltage Critically Low Warning	Engine starting battery voltage falls below 11 V for more than 10 seconds. Inhibited during the engine crank cycle. Clears when the battery voltage returns to an acceptable level.	Check the battery rating and condition. Check the battery charger operation. Charge or replace the battery.
Battery High Warning	Battery Voltage High Warning	Engine starting battery voltage rises above 133% (16 V) of the battery voltage setting for more than 10 seconds. Inhibited during the engine crank cycle. Clears when the battery voltage returns to an acceptable level.	Check the battery rating and condition. Check the battery charger operation.
Battery Low Warning	Battery Voltage Low Warning	Engine starting battery voltage falls below the battery voltage setting (typically 12.5 volts) for more than 90 seconds when the engine is not running. Inhibited during the engine crank cycle. Clears when the battery voltage returns to an acceptable level.	Check the battery rating and condition. Check the battery charger operation. Charge or replace the battery.
Chk DateTime Warning	Verify Date Time Setting	The time and date have not been set on the generator controller.	Enter the date and time using the RDC2 controller. See Figure titled: Overview Menu and Date and Time Menu.
Coolant Level Low Shutdown	Coolant Level Low	The coolant level switch input has been activated.	Check coolant level. Check radiator hoses for signs of leaks. Contact an authorized dealer for service.
Coolant Lvl Low Shutdwn	Low Coolant Level Shutdown	The coolant level switch input has been activated.	Check coolant level. Check radiator hoses for signs of leaks. Contact an authorized dealer for service.
Coolant Temp High Warning	Coolant Temperature High	Coolant temperature is too high.	Check coolant level. Check the enclosure vents for obstructions. Contact an authorized dealer for service.
Crank Lost Shutdown	Crank Sensor Signal Lost	Crankshaft Position Sensor (CPS) timeout error occurred.	Contact an authorized dealer for service and provide the fault code.
ECM warnings (any warnings with ECM in the fault name)	ECM warnings (any warnings with ECM in the fault name)	This group of faults includes a wide variety of faults that originate from the engine ECM and also contain ECM in the fault name.	Contact an authorized dealer for service and provide the fault code.

Fault (RDC2)	Fault (OnCue® Plus)	Condition	Check
Emerg Stop Shutdwn	Emergency Stop	The emergency stop switch has been activated, or there has been an open circuit in the wiring.	Determine the cause for the Emergency Stop. Verify that the condition has been corrected and it is safe to apply power to the load before resetting the emergency stop button. Contact an authorized dealer for service.
Engine Speed High shutdowns	Engine Speed High	Engine speed exceeds 115% of the normal running speed for more than 0.3 seconds.	Contact an authorized dealer for service.
Eng Speed Low Shutdwn	Engine Speed Low	Engine speed drops below 85% of the normal running speed for more than 3 seconds.	Reduce the load by turning off appliances. Contact an authorized dealer for service.
Exer Not Sch Warning	ATS Exercise Not Scheduled	Exercise Not Scheduled. No exercise has been scheduled on the RDC2 controller.	See section titled: Exercise for instructions to set the exerciser.
Frequency Over Shutdown	Generator Frequency High	Governed frequency exceeds 110% of the system's frequency setpoint for more than 10 seconds. Function becomes active 10 seconds after engine start (10 second inhibit).	Contact an authorized dealer for service.
Frequency Under Shutdown	Generator Frequency Low	Governed frequency falls below 90% of the system frequency setting for more than 10 seconds, or 1 Hz below the system frequency setting for more than 60 seconds. Function becomes active 10 seconds after engine start (10 second inhibit).	Reduce the load by turning off appliances and restart the generator set. Contact an authorized dealer for service.
Ground Fault Warning	Ground Fault Warning	The digital input for Ground Fault Warning is active (low). (PIM required.)	Check customer equipment connected to the PIM.
Lo Crank Vlt Warning	Low Cranking Voltage	Low cranking voltage. Battery voltage falls below 60% of system battery voltage for more than 6 seconds while the starter is engaged.	Charge or replace the battery.
Locked Rotor Shutdwn	Locked Rotor	No engine rotation is sensed during cranking. Shuts down 3 seconds after the fault is detected.	Contact an authorized dealer for service.
Main Power Overload Shutdown	Main Power Overload	Main power overload. An over current fault on the 70 controller power output (short circuit).	Contact an authorized dealer for service.
Maint Req'd Warning	Maintenance Required Warning	Engine maintenance is due.	Check the maintenance schedule in the operation manual for tasks such as changing the oil, spark plugs or the air filter.
Not in Auto Warning	Not In Auto	The generator set is not in Automatic (standby) mode. Remote start and stop commands from a transfer switch or remote switch will be ignored.	Press AUTO to place the generator set in Automatic mode, when appropriate.
Oil Pressure Low Warning or Shutdown	Engine Oil Pressure Low	The engine ECM indicates low oil pressure. Note: The low oil pressure shutdown does not protect against low oil level. Check the engine oil level regularly as recommended in the Maintenance Schedule.	Check for signs of leaks in the lubrication system. Check the oil level and add oil if the level is low. Contact an authorized dealer for service.
Oil Temperature High Warning	Oil Temperature High	High oil temperature has been detected.	Contact an authorized dealer for service.
Over Crank Shutdwn	Over Crank	Three unsuccessful starting attempts.	Check the fuel supply, spark plug, and battery. Check for loose connections. Contact an authorized dealer for service.

Fault (RDC2)	Fault (OnCue® Plus)	Condition	Check
Spd Sens Flt Shutdwn	Speed Sensor Fault	Engine speed sensor has failed or engine stalled. ECM is no longer reporting valid speed.	Contact an authorized dealer for service.
Volts L1-L2 High Shutdwn	Generator Voltage AB High	Generator Voltage High. Output voltage exceeds 120% of the system nominal voltage for more than 2 seconds.	Contact an authorized dealer for service.
Volts L1-L2 Low Shutdwn	Generator Voltage AB Low	Generator Voltage Low. Output voltage falls below 80% of the nominal system voltage for more than 10 seconds.	Reduce the load by turning off appliances and restart the generator set. Contact an authorized dealer for service.
Volts L2-L3 High Shutdwn	Generator Voltage BC High	Generator Voltage High. Output voltage exceeds 120% of the system nominal voltage for more than 2 seconds.	Contact an authorized dealer for service.
Volts L2-L3 Low Shutdwn	Generator Voltage BC Low	Generator Voltage Low. Output voltage falls below 80% of the nominal system voltage for more than 10 seconds.	Reduce the load by turning off appliances and restart the generator set. Contact an authorized dealer for service.
Volts L3-L1 High Shutdwn	Generator Voltage CA High	Generator Voltage High. Output voltage exceeds 120% of the system nominal voltage for more than 2 seconds.	Contact an authorized dealer for service.
Volts L3-L1 Low Shutdwn	Generator Voltage CA Low	Generator Voltage Low. Output voltage falls below 80% of the nominal system voltage for more than 10 seconds.	Reduce the load by turning off appliances and restart the generator set. Contact an authorized dealer for service.

Figure 10 Controller Fault Messages

2.6.5 Status and Notice Messages

The Status and Notice messages shown in Figure 11 are displayed during generator set operation. These informational messages do not indicate faults.

Message	Type	Description
Advance Diagnostic Active	Status	During any exercise mode, shutdown occurs due to any other condition(Fault) excluding Emergency Shutdown, Main Power Overloaded Shutdown, Low Cranking Voltage Shutdown.
Advance Diagnostic Active Ended	Status	Advance Diagnostic mode is ended
Always On	Notice	Any of the following optional boards are connected to controller 1. LCM 2. PIM
Ats Exercise Active	Notice	The generator is in exercise mode.
ATS Exercise mode End Prematurely	Status	Exercise mode ends prematurely.
Ats Loaded Test Active	Status	The ATS contactor position is source2 and user places the controller in RUN mode
Ats Position Source 1 selected	Status	The ATS contactor position is source1.
Ats Position Source 2 selected	Status	The ATS contactor position is source2.
ATS Test End	Status	ATS Test ended.
Ats Test Ended Prematurely	Status	ATS Test ended prematurely.
Ats Unloaded Test Active	Status	Generator is started by pressing RUN Button.
Auto Recovery	Status	Unit has reset due to unexpected error.
Backup Parameter Loaded	Status	Test event log command is initiated from Site Tech.
Default Parameters Loaded	Status	When the engine stops, status is updated.
Diagnostic Exercise Active	Status	Variable speed exercise is running.
Emergency Power System Supplying Load	Notice	The utility power is absent and the generator is powered on. This notice is displayed on SiteTech.
Engine Cool Down Active	Notice	The generator is in cool down mode.
Engine Start Delay Active	Notice	The engine start delay is active. The engine will start when the delay expires.
Engine Started	Status	When the engine starts, status is updated.
Engine Stopped	Status	When the engine stops, status is updated.
Exercise mode End	Status	Exercise mode ended.
File System Error	Status	Parameter/event saving fails after 3 retries.
Forced to Auto Status	Status	Mode has changed to AUTO mode.
Generator Running	Notice	The engine is started and a valid engine speed has been achieved. This notice is displayed in SiteTech.
Load Priority X Shed	Notice	Priority X (1- 6) load with is disconnected.
Loaded Full Speed Exercise Active	Status	Loaded full speed exercise is running.
Maintenance Timer Reset	Status	The user has reset the maintenance timer.
Normal Power Source Unavailable	Notice	Utility power is unavailable.
Remote Start	Status	The remote start contact is closed.
Unloaded Full Speed Exercise Active	Status	Unloaded full speed exercise is running.

Figure 11 Status and Notice Messages

2.6.6 Event Log

The event log displays up to 1000 controller faults and notices, starting with the most recent event. Events are numbered 1-1000, with 1 being the most recent. Each event is displayed with the date and time of the event, the number of the event, a code to indicate whether the event was a warning (W), shutdown (S), or informational notice (I), the engine hours at the time of the event, and the event description.

Procedure to View Event History

1. Press Select to enter the main menu.
2. Press the down arrow to step down to the event log.
3. Press Select to display the most recent event. See Figure 12.
4. Press the down arrow to step to the next event.
5. Use the up and down arrow buttons to view events.
6. Press the Select button to exit the event log.

To stop viewing the event history before the last event, press the select button to return to the main menu.

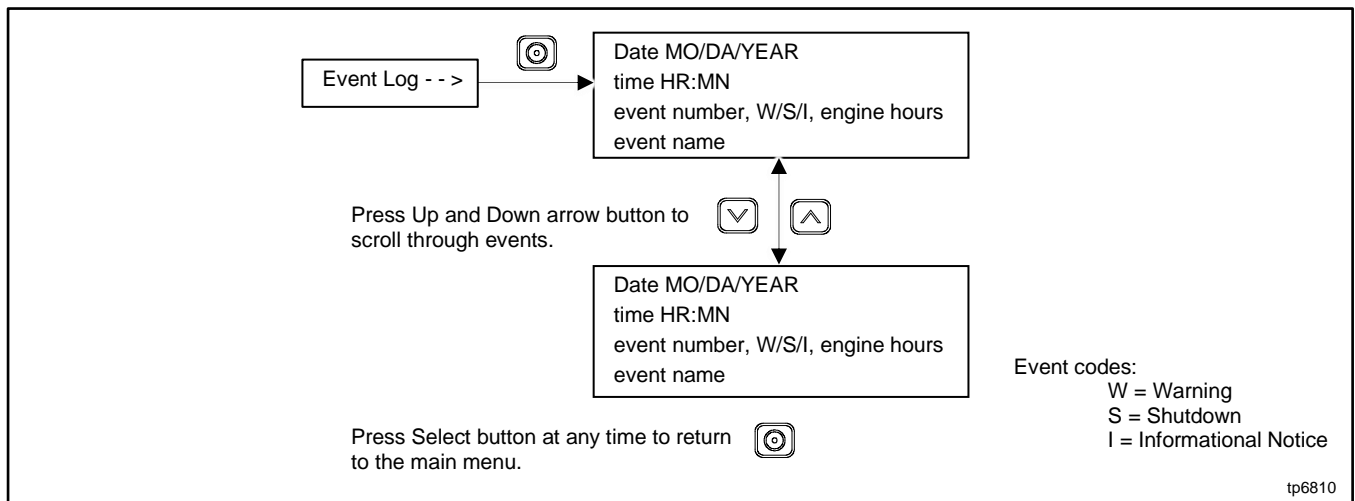

Figure 12 Event Log

2.7 Model RXT Transfer Switch Operation

The RDC2 generator set/transfer switch controller manages automatic transfer switch (ATS) functions when connected to a Kohler® Model RXT transfer switch through the ATS interface board. Refer to the Model RXT Operation/Installation Manual for information about the transfer switch operation.

2.7.1 Source Availability

The Model RXT transfer switch supplies voltage sensing data to the RDC2 controller through the ATS interface board. If the source voltage falls below the undervoltage dropout setting, the source is considered to have failed. See Figure 13.

Item	Setting
Accuracy	±5%
Undervoltage Dropout	90% of Pickup
Undervoltage Pickup	90% of Nominal

Figure 13 Voltage Sensing Parameters

The RDC2 controller also has a set of power system LEDs below the pushbuttons. The power system LEDs indicate which power sources are available and which source is supplying power to the building. See figure titled: RDC2 User Interface.

Note:

The power system LEDs operate only if a Model RXT transfer switch is connected. They will not operate if a Model RDT transfer switch is used.

2.7.2 ATS Control Sequence of Operation

See Figure 14 for time delay settings.

Normal Source Fails:

1. The load control contact opens.
2. The engine start time delay times out.
3. The generator set is signaled to start.
4. The generator starts and the emergency source becomes available.
5. The normal-to-emergency time delay times out.
6. The transfer switch transfers to the emergency source.
7. The load control contact time delay times out.
8. The load control contact closes.

Normal Source Returns:

1. The emergency-to-normal time delay times out.
2. The contactor transfers to the normal source.
3. The engine cooldown time delay times out.
4. The generator is signaled to stop.

Time Delay	Setting	Description
Engine Start	3 seconds	Time delay after utility source is lost until the engine start cycle begins. Guards against starting the generator set because of a brief change in the utility source.
Transfer, Normal to Emergency	3 seconds	Time delay after emergency source becomes available until transfer to emergency source.
Transfer, Emergency to Normal	2 minutes	Time delay after the utility source returns until transfer back to normal. Ensures that the utility source is stable before transferring from the emergency source.
Load Control	5 minutes	See section titled: ATS Load Control Relay Time Delay. Allows delayed connection of selected loads to the generator set to prevent simultaneous starting of large motors after transfer to the emergency source. Recommended for delayed starting of air conditioners.

Figure 14 Time Delays

2.7.3 Time Delays

Time delays are factory-set to the values shown in figure titled: Time Delays. An authorized dealer or service technician can adjust time delays using a personal computer and Kohler® SiteTech™ software.

Time delays described in this section operate only when the controller is connected to a Kohler® Model RXT transfer switch.

The engine start and load transfer time delays prevent engine start and load transfer caused by brief variations in the utility power source.

2.7.4 ATS Load Control Relay Time Delay

The load control time delay allows delayed starting of large motor loads (such as air conditioners), preventing simultaneous starting of large motors after transfer to the generator set. The load control time delay is fixed at 5 minutes. It is not adjustable.

The load must be connected to the load control output on the interface board of the Model RXT transfer switch. See the transfer switch operation and installation manual for connection instructions.

Section 3. RDC2 Controller Operation

3.1 RDC2 Generator Set/Transfer Switch Controller

The generator sets are equipped with the RDC2 generator set/transfer switch controller. The RDC2 controls the following power system components:

- The generator set
- Model RXT automatic transfer switch (ATS)
- Load management device
- Programmable interface module (PIM)

RDC2 Controller features include:

- Two-line x 16-character backlit LCD display with adjustable contrast
- OFF, AUTO, and RUN generator set master control buttons
- Generator set status indicating LEDs (OFF, AUTO, RUN)
- Up, Down, and Select buttons for navigation through menus and adjustments
- Power system indicator LEDs to show utility and generator source status, and to show which source (utility or generator) is supplying power to the building (Model RXT automatic transfer switch is required)

3.2 Controls and Indicators

Figure 15 illustrates the keypad, display, and indicators on the controller's user interface.

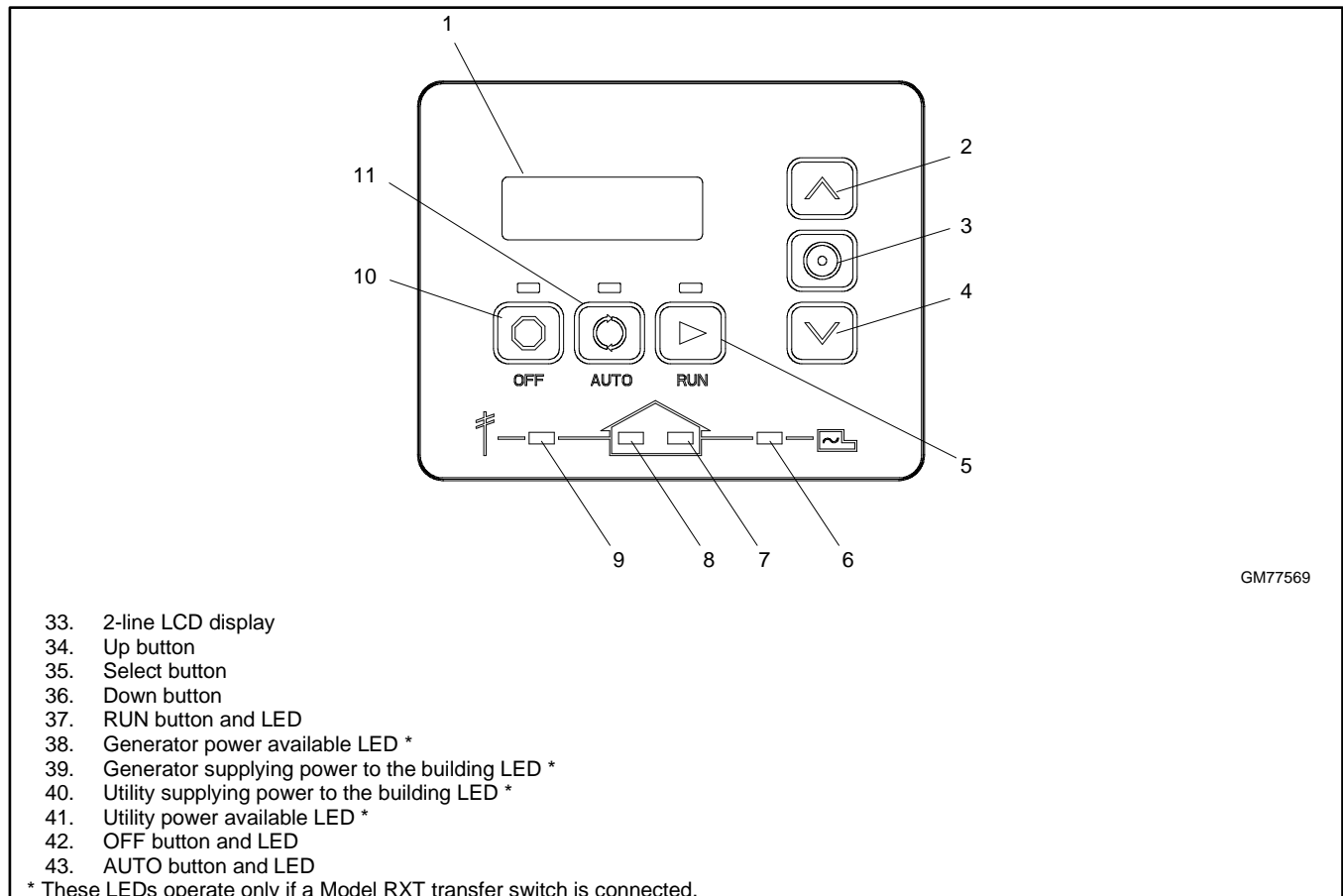

Figure 15 RDC2 User Interface

3.2.1 Controller Keypad

The Run, Off, and Auto buttons control the generator set as described in Figure 16. Use the Select, Up arrow, and Down arrow buttons to navigate through the menus and change settings, if necessary. See section titled: Generator Set Operation for instructions.

Button	Button Function
RUN	Starts the generator set. The engine start time delay is ignored.
OFF	Stops the generator set. The cooldown time delay is ignored. During the engine crank cycle, pressing OFF will stop the crank cycle. Press OFF to clear faults and reset the controller.
AUTO	Places the generator set in Automatic (standby) mode.
Down arrow	Use to navigate through menus and change settings. This manual contains instructions to navigate the controller menus and adjust settings on the RDC2 controller.
Select	
Up arrow	

Figure 16 Pushbutton Operation

3.2.2 LED Indicators

LEDs above the RUN, OFF, and AUTO buttons indicate the mode of operation.

The RDC2 controller also has a set of power system LEDs below the pushbuttons. The power system LEDs indicate which power sources are available and which source is supplying power to the building (based on the position of the Model RXT transfer switch). See figure titled: RDC2 User Interface.

Note:

The power system LEDs operate only if a Model RXT transfer switch is connected. They will not operate if a Model RDT transfer switch is used.

LED	LED Operation
RUN	Lights when the generator set has been started locally by pressing the RUN button. Remote start and stop commands are ignored.
OFF	Lights for 2 seconds, then flashes every 2 seconds when the generator set and controller are off. Remote start/stop commands have no effect. The exercise cycle will not run. In Auto mode, OFF LED flashes quickly to indicate a fault shutdown. Attention required. Identify and correct the fault condition before resetting the controller.
AUTO	Lights when the generator is in automatic (standby) mode. Generator set will respond to engine start and stop commands from the controller (for example, exercise start and stop commands), an ATS, or OnCue® Plus. Time delays operate as described in section titled: Generator Set Operation.
Utility Power Available *	Lights when utility power is available.
Building on Utility Power *	Lights when the building load is connected to utility power through the RXT transfer switch.
Generator Power Available *	Lights when generator power is available.
Building on Generator Power *	Lights when the building load is connected to generator power through the RXT transfer switch.
* These LEDs operate only if a Model RXT transfer switch is connected.	

Figure 17 RDC2 Controller LED Operation

3.2.3 LCD Display

The controller is equipped with a two-line x 16-character backlit liquid crystal diode (LCD) display with adjustable contrast. When the generator is running, the controller automatically scrolls through the displays shown in Figure 18. When the system is in AUTO, the LCD display scrolls through the status messages shown in Figure 18.

When a fault or warning condition exists, the controller will show the corresponding message. See section titled: Faults for more information on fault and warning messages.

Controller menus display power system information, including status information for the engine, generator, and optional RBUS accessories, exercise settings, and event history. Some menus allow changes to the controller settings.

The display contrast is adjustable. Navigate to the Genset System menu and step down to the Contrast screen. Press the Select button, and then use the up and down arrow buttons to adjust the contrast. See section titled: Changing Settings and section titled: Generator Set Information Menu.

The display backlight turns off after about a minute of no activity. The backlight turns on when a button is pressed or when the generator set starts.

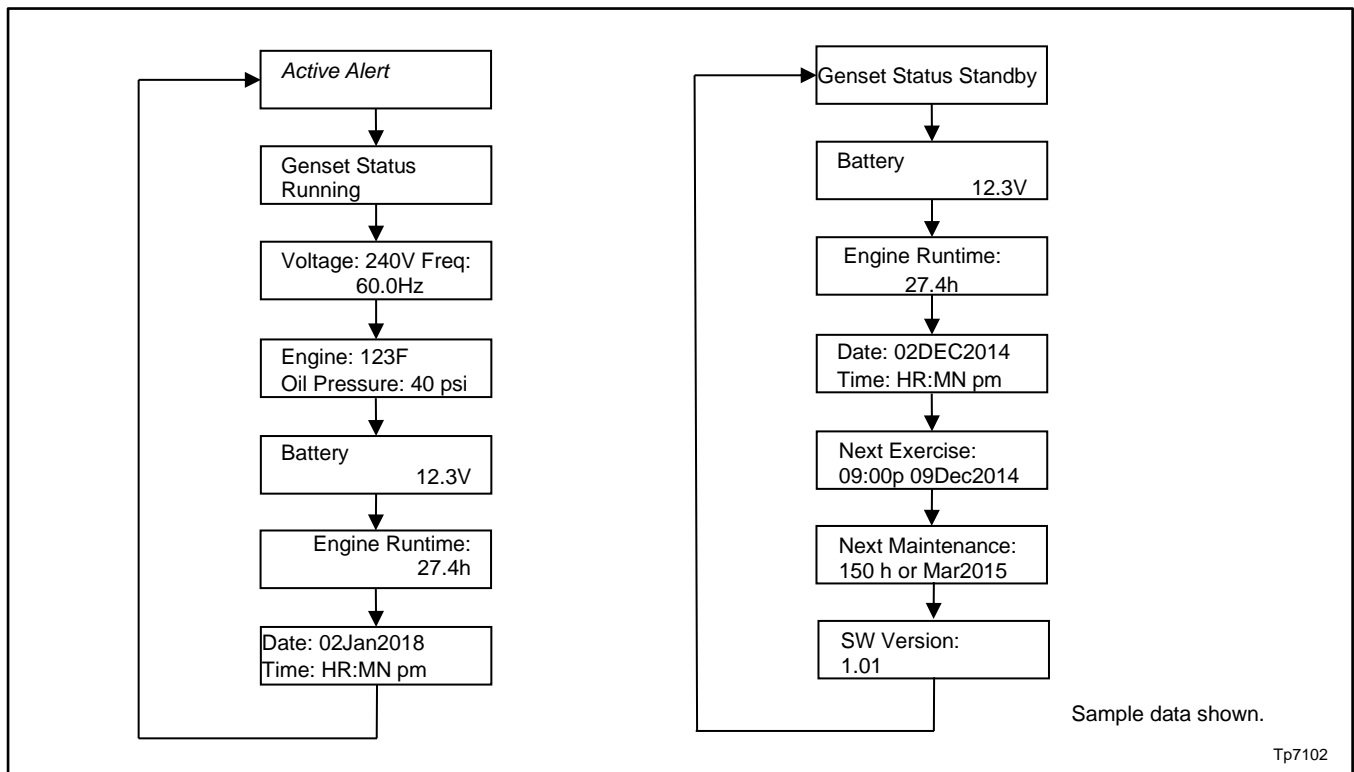

Figure 18 Autopaging Displays, Generator Running and Automatic Mode

3.3 Controller Power

The RDC2 controller is powered by the generator set engine starting battery and the built-in battery charger.

Note:

To disconnect controller power, disconnect the battery and the utility power to the generator set.

If controller power is disconnected and reconnected, you will be prompted to set the time, date, and exerciser. The first setting will flash. Press the Up and Down arrow buttons to change the setting. Press Select to save the setting and move on to the next. Repeat until all settings are saved and the controller returns to the main menu. See section titled: Changing Settings for more detailed instructions to change settings on the RDC2. See section titled: Exercise for more detailed instructions to set the exerciser or change the exercise settings.

3.4 Battery Charging

The controller includes a built-in battery charger to maintain the engine starting battery. The RDC2 controller monitors the battery voltage and provides a constant $13.4 \pm 2\%$ VDC voltage and maximum 2.5 amps to charge the battery.

The installer must connect utility power 120 VAC/60Hz provided from the building on a breaker-protected circuit for the built-in battery charger. See the Installation Manual for instructions to connect the utility power for the battery charger.

3.5 Changing Settings

Some settings can be changed from the controller keypad. The controller settings and generator set output are factory-set and should not require field adjustment under normal circumstances. Check and adjust the settings and/or output when:

- The controller has been replaced.
- The voltage requires adjustment for a particular application.
- Troubleshooting generator set problems.

Have controller setup and adjustment performed only by an authorized Kohler dealer or authorized representative.

The following procedure explains how to change settings. See Figure 19 for an example using the Date and Time settings.

Note:

Use caution when navigating the controller menus and changing the settings. In some menus, pressing the Select button can enable editing of the controller settings. Changing some settings to incorrect values can adversely affect generator set operation or render the unit inoperable.

Procedure to Change Settings

1. Press the Select button to enter the main menu.
2. Press the down arrow button until the desired menu is displayed. The Date and Time menu is used for the example in Figure 19.
3. Press the Select button to enter the selected menu. See Figure 19.
4. Press the down arrow button to step through the parameters in the selected menu.
5. To change a setting, press the Select button. The selected setting flashes.
6. Press the up or down arrow buttons to increase or decrease the setting.
7. When the desired setting is shown, press Select. The value stops flashing. If there are additional adjustable settings on the screen, the next setting flashes. For example, in the date menu, the year, month, and day can be adjusted.
8. Repeat steps 5 through 7 for each setting on the screen.
9. Press the down arrow to step to the next screen.
10. To exit, press the down arrow button until Return is displayed. Press the Select button to exit the menu.
11. Press the AUTO or OFF button to exit the main menu.

Note:

If no buttons are pushed, the controller exits the menus and returns to the generator set status display after 5 minutes.

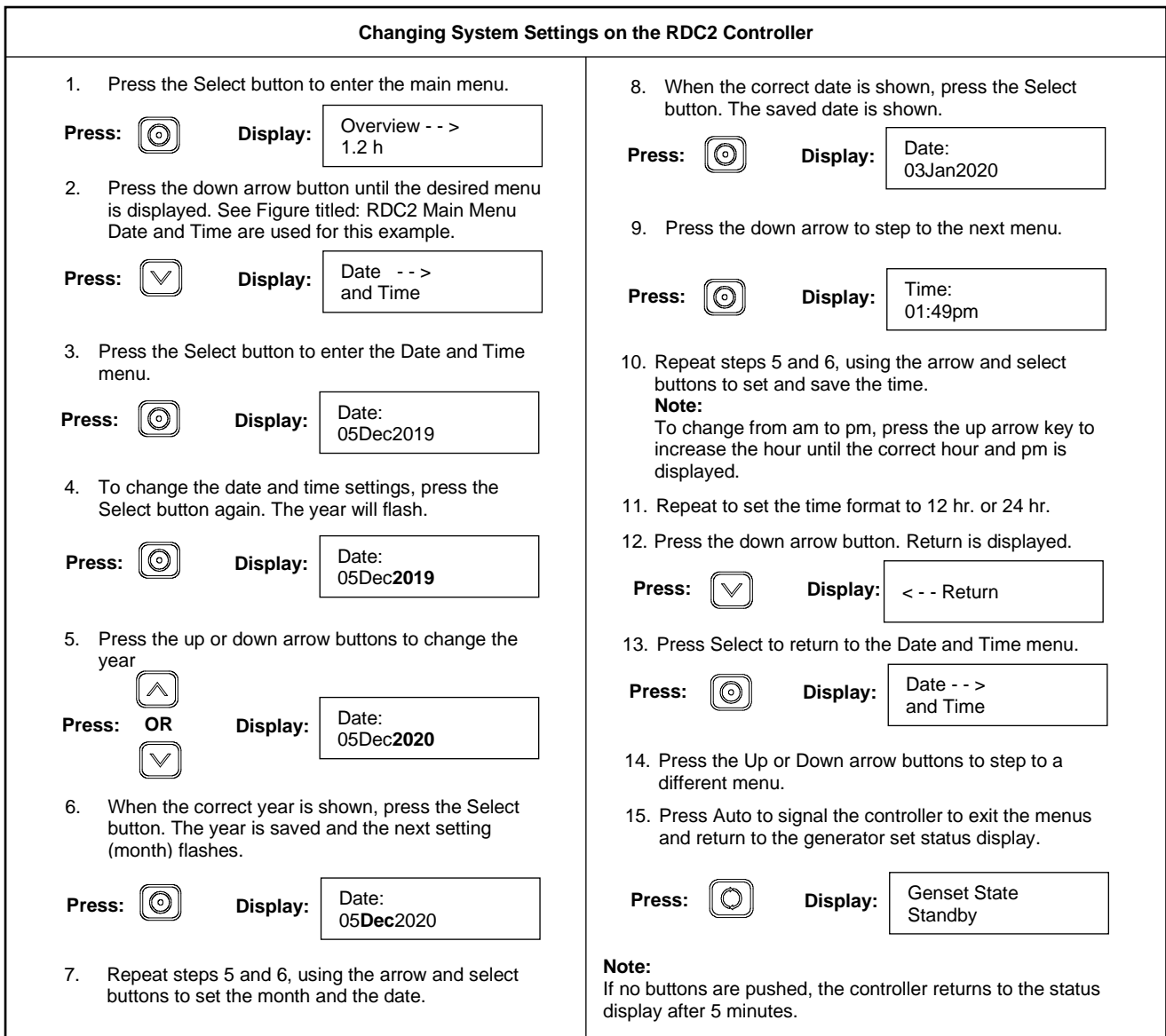

Figure 19 Changing Settings

3.6 Controller Menus

The following sections show the RDC2 controller menus and submenus. Use the Select button and the up and down arrow buttons to navigate the menus as shown in the diagrams.

Note:

Use caution when navigating the controller menus. In some menus, pressing the Select button can enable editing of the controller settings. Changing the settings to incorrect values can adversely affect generator set operation or render the unit inoperable.

If a setting on the controller display is flashing, edit mode has been enabled. Press the OFF or AUTO button to exit the edit mode.

3.7 Main Menu

Press the Select button once to bring up the main menu. Overview is displayed. See Figure 20. Press the down arrow button to step to the next menu, Engine Metering. Use the UP and DOWN arrow buttons to step up and down through the menus shown in Figure 20.

The controller will exit the main menu after 5 minutes if no buttons are pressed. To exit the main menu immediately, press the controller's OFF or AUTO button.

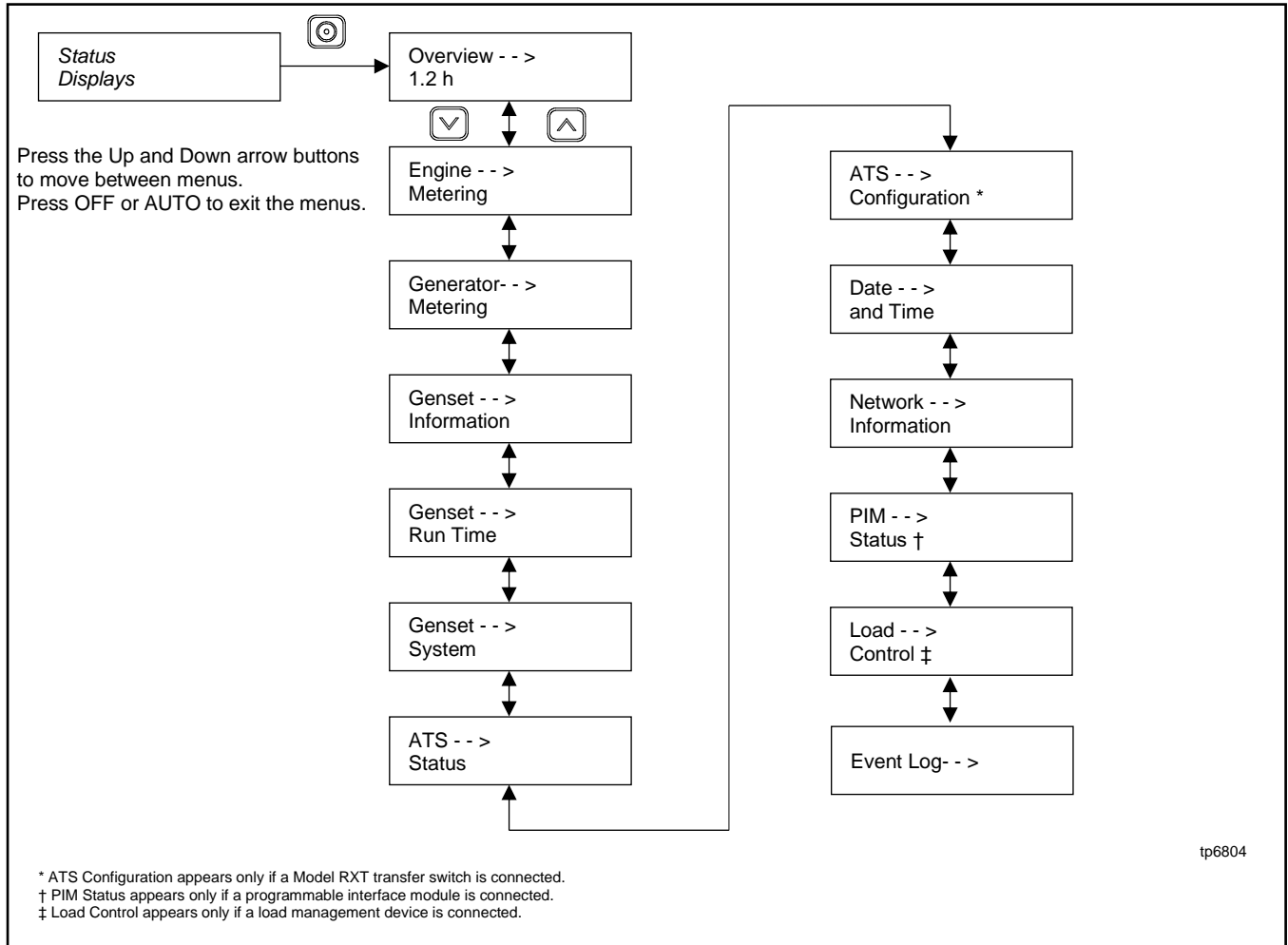

Figure 20 RDC2 Main Menu

3.8 Overview Menu

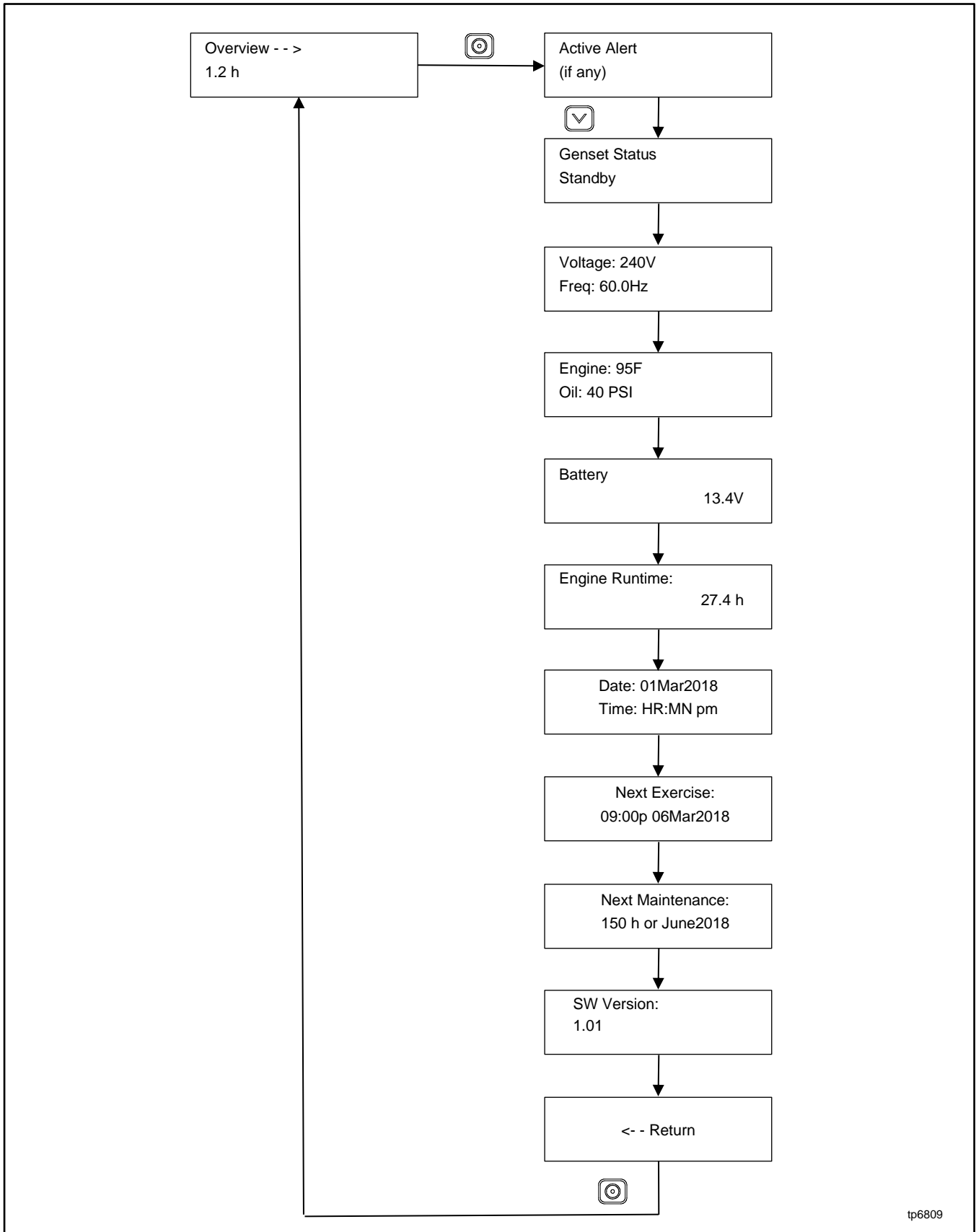

Figure 21 Overview Menu

3.9 Engine Metering Menu

The engine metering menu displays engine status information as shown in Figure 22. This menu displays status information only. No settings can be changed from this menu.

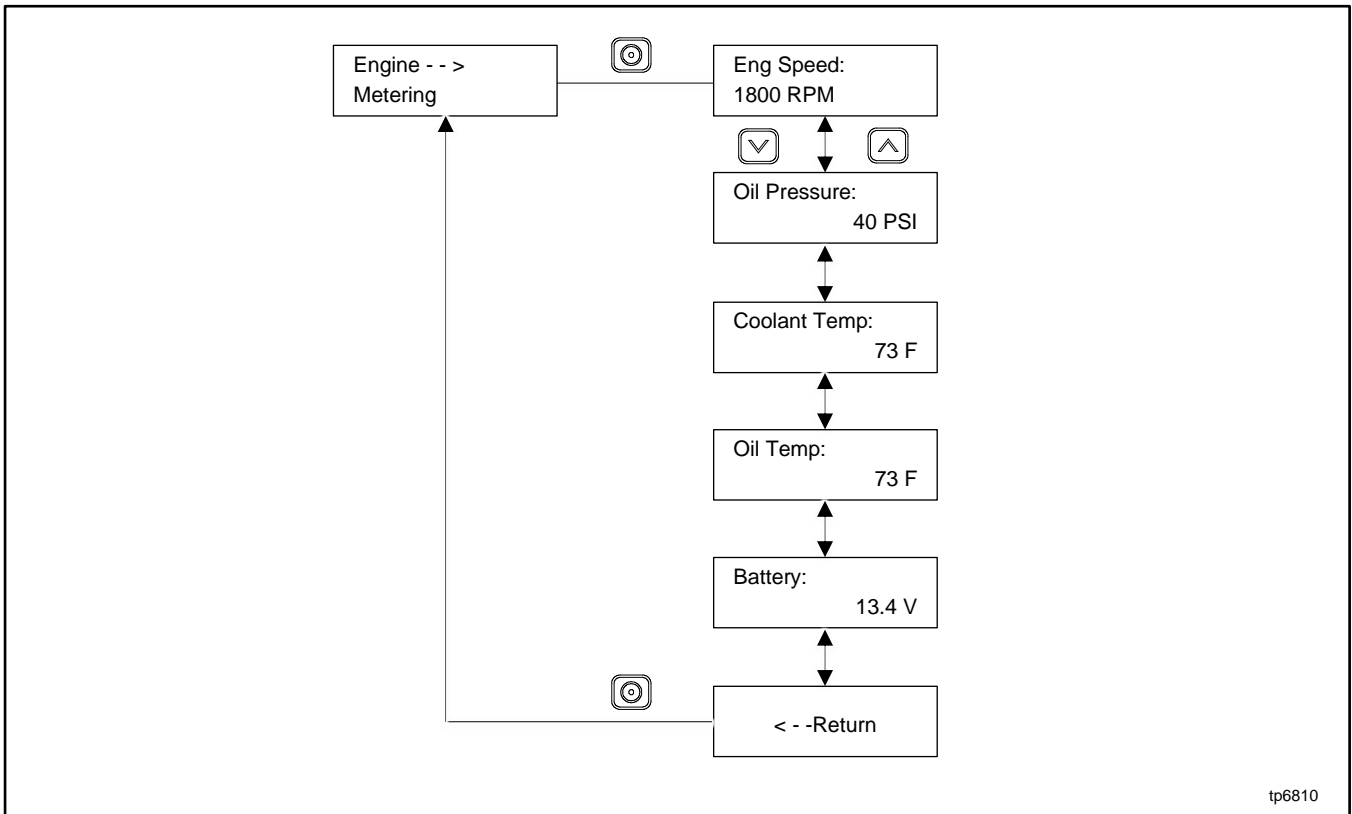



Figure 22 Engine Metering Menu

3.10 Generator Metering Menu

 DANGER	Hazardous voltage. Will cause severe injury or death. This equipment must be installed and serviced by qualified electrical personnel.
	

The generator metering menu displays the generator voltage and frequency. See Figure 23.

The voltage calibration mode can be entered from the generator metering menu.

Voltage Calibration

The voltage calibration mode can be entered from the Generator Metering menu. Contact a Kohler-authorized dealer for service.

The Reset Calibration menu allows you to set the voltage reading back to the original value after calibration, if necessary. See Figure 23.

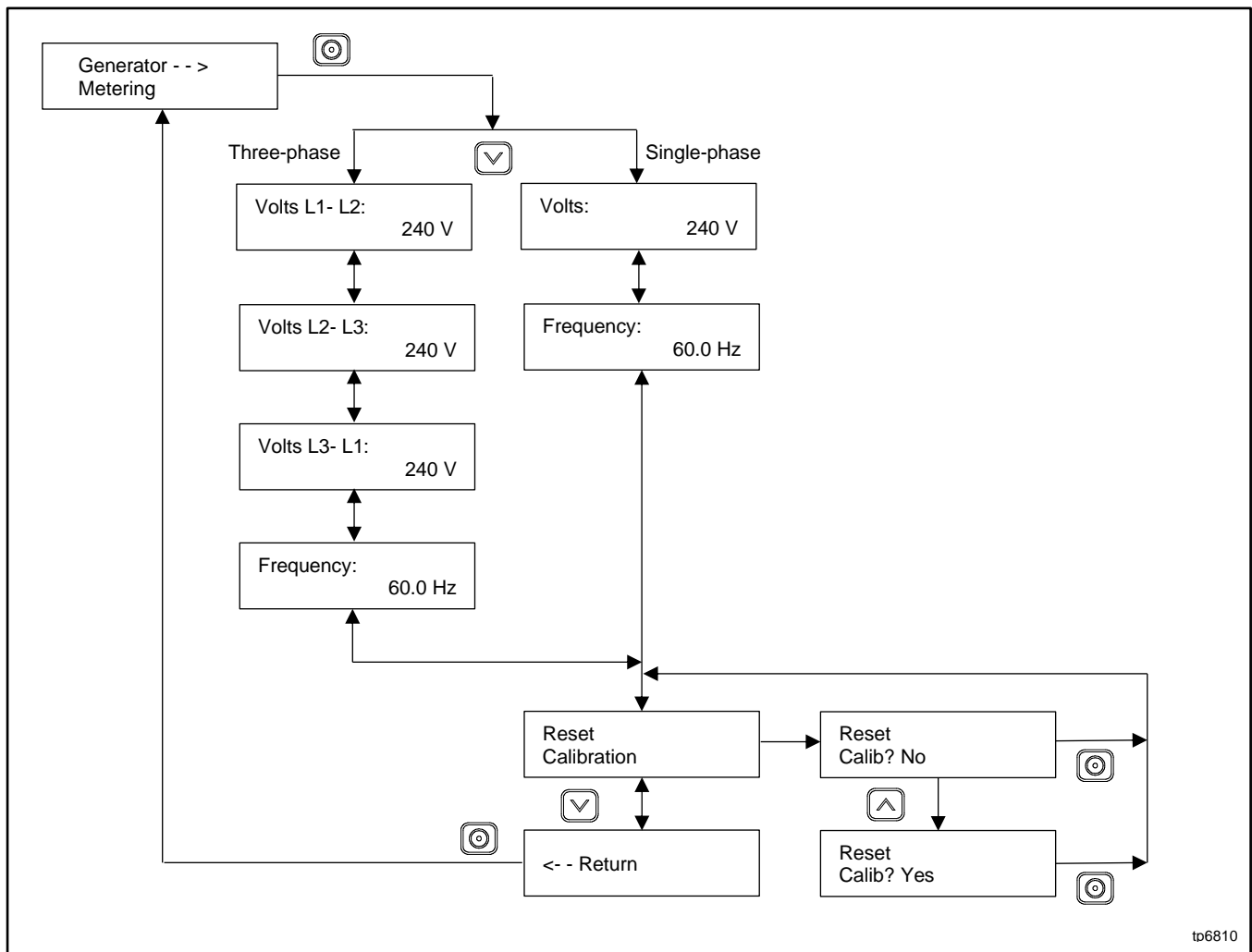

Figure 23 Generator Metering Menu

3.11 Generator Set Information Menu

The generator set model number and serial numbers are displayed. No changes are allowed from this menu.

Model and serial numbers are factory set and should not require changes in the field, except in the event that the controller is being replaced. A personal computer running Kohler® SiteTech™ software is required to enter the generator set model number and serial numbers on a replacement controller. Contact an authorized Kohler dealer for service.

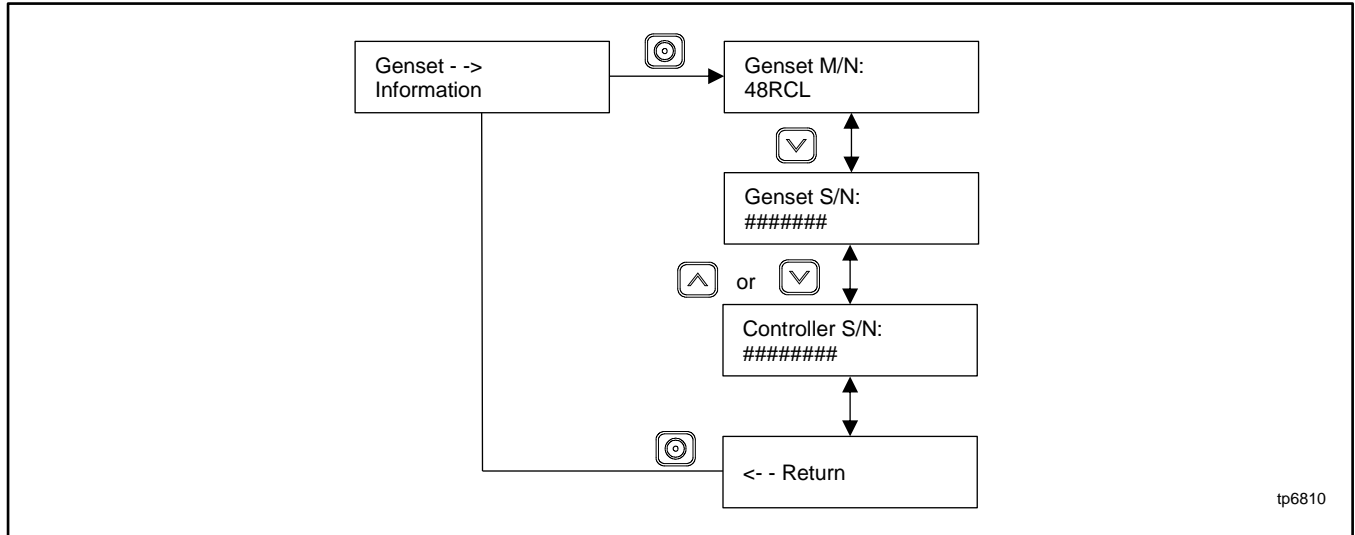

Figure 24 Generator Set Information Menu

3.12 Genset Run Time Menu

The data shown in Figure 25 are displayed. No changes are allowed from this menu.

The Next Maintenance menu shows the number of hours of generator set operation until maintenance is required. The estimated date for the next scheduled maintenance is also displayed. The maintenance reminder intervals are based on the engine manufacturer's recommendation for changing the oil. Refer to section titled: Scheduled Maintenance, for maintenance instructions.

After changing the oil and performing other recommended maintenance, go to the Overview menu to reset the maintenance timer. See section titled: Oil and Filter Change for instructions to reset the maintenance timer.

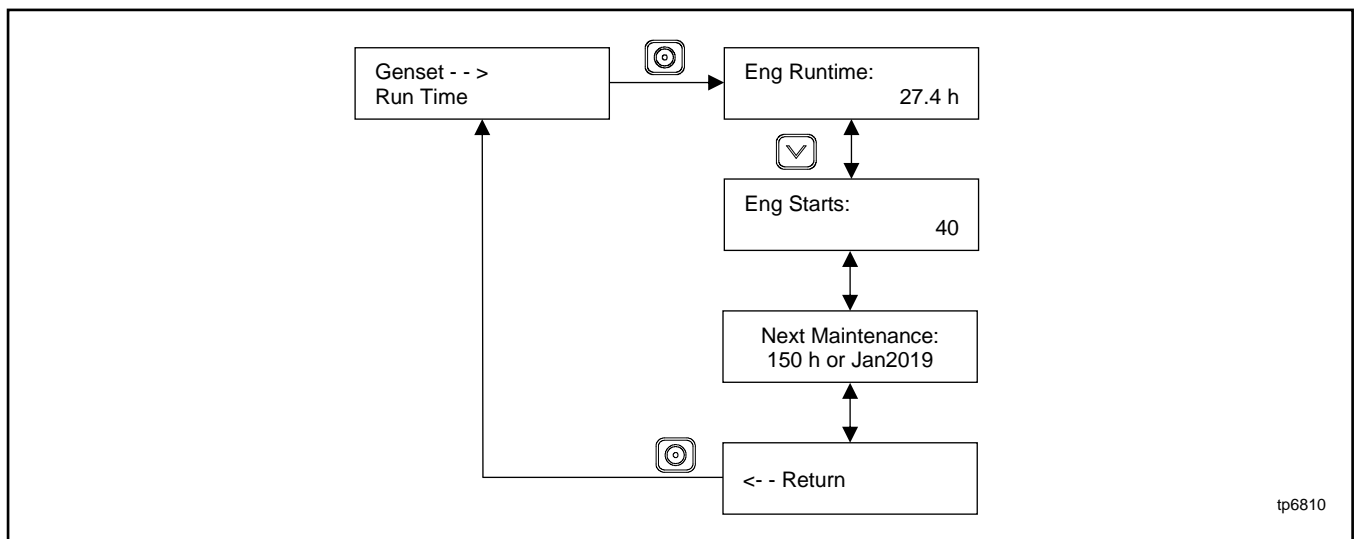

Figure 25 Generator Set Run Time Menu

3.13 Genset System Menu

The genset system menu displays the system information shown in Figure 26. Generator sets are factory set and should not require changes to the system settings in the field.

A Kohler authorized dealer or service technician can adjust these settings, if necessary. If the generator set is reconnected to a different voltage or the system settings require adjustment for some other reason, see section titled: Changing Settings for instructions to enable editing and change the system settings.

Note:

Use caution when navigating the controller menus. In some menus, pressing the Select button can enable editing of the controller settings. Changing the settings to incorrect values can adversely affect generator set operation or render the unit inoperable.

Voltage Regulator (VR) Voltage Adjust

The generator set voltage is factory set and typically does not require adjustment in the field. If voltage adjustment is required, contact a Kohler authorized dealer for service. Refer to the generator set Installation Manual for instructions to adjust the voltage.

Fuel Type

The fuel type, LP or natural gas, is shown. Do not change the fuel type in this menu unless the generator's fuel system has been converted by an authorized dealer or service technician.

Setting the Exerciser

Use the Genset System menus to set the generator set exerciser. Refer to section titled: Exercise for instructions to set the exerciser and for more information about exercising the generator set.

After a scheduled exercise run, the Next Exercise time and date will be updated automatically based on the Exercise Frequency setting.

Language

The language for the controller display can be set to: English, French, Spanish, Dutch, or German.

Adjusting the Display Contrast

To adjust the display contrast, use the down arrow button to step to the Contrast menu. Press the Select button, and then use the up and down arrow buttons to adjust the contrast. Press the Select button to save the contrast setting.

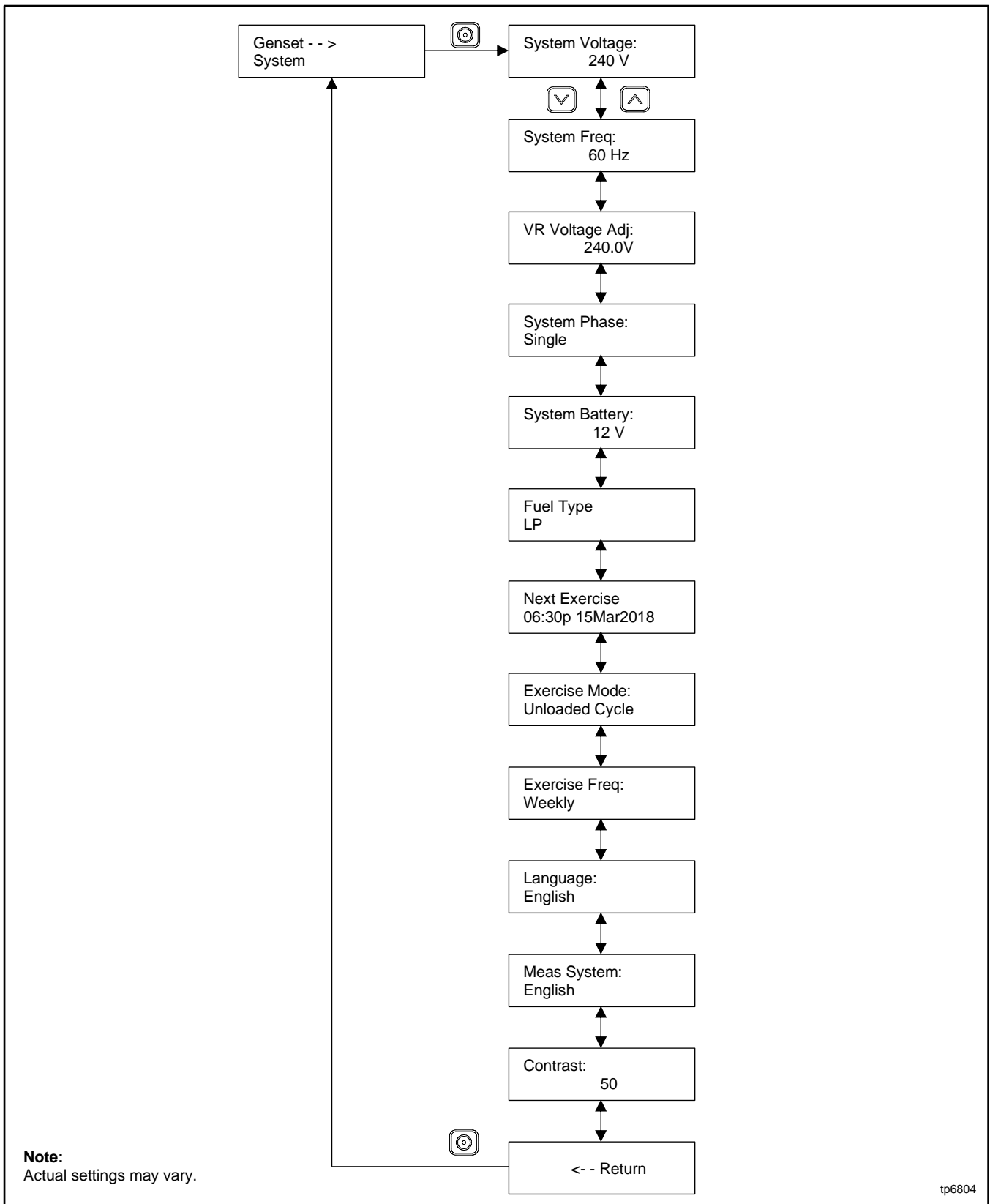

Figure 26 Genset System Menu

3.14 ATS Status Menu

ATS menus appear if a Model RXT transfer switch is connected to the generator set. If no transfer switch is connected, or another model ATS is connected to the engine start connections, Remote ATS is displayed on the ATS Status screen.

The ATS Status menu displays Model RXT transfer switch and source information.

The voltage shown in these menus can be calibrated. Contact an authorized dealer for service if calibration is required.

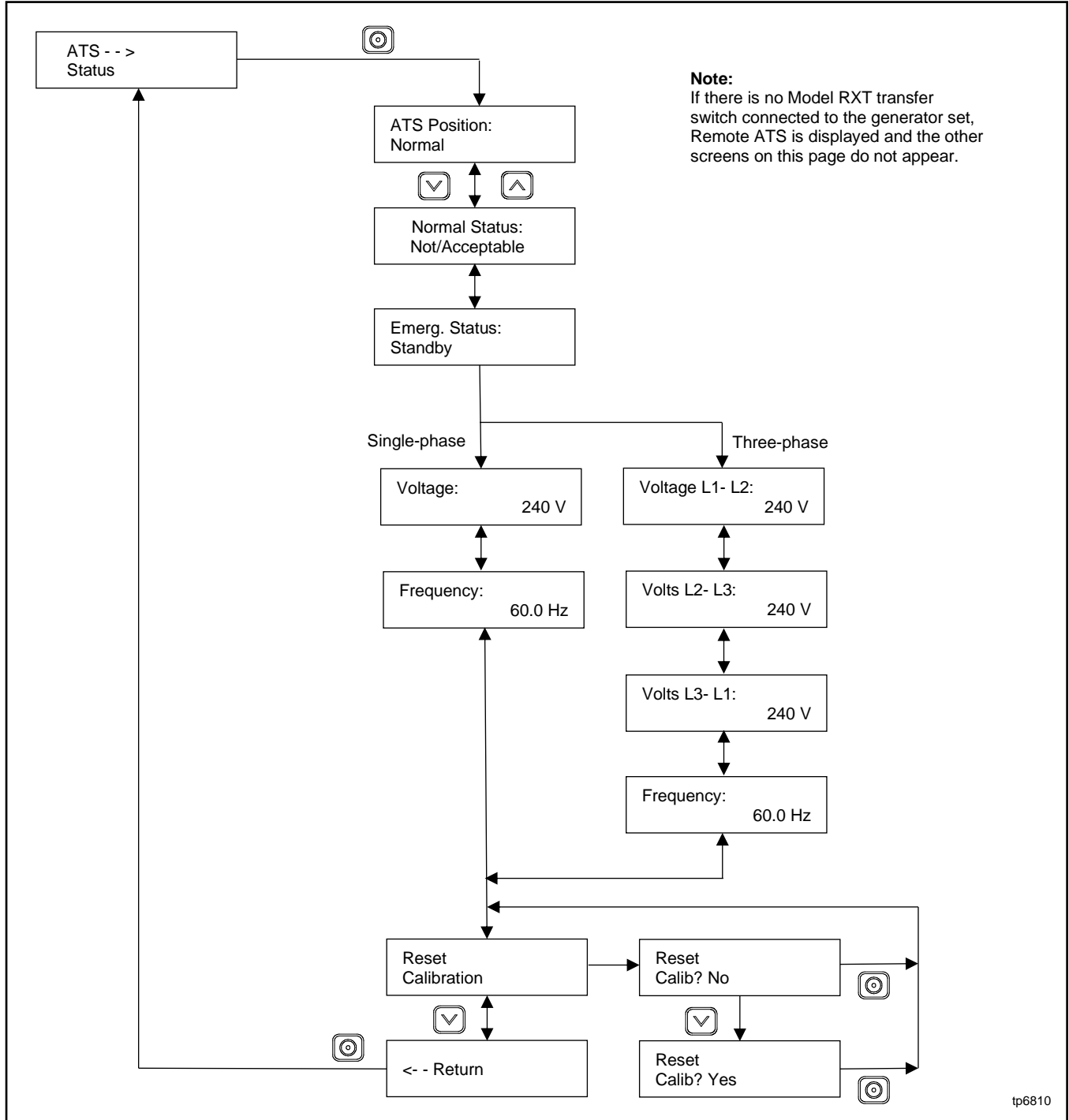

Figure 27 ATS Status Menu, with Calibration

3.15 ATS Configuration Menu

Note:

The ATS Configuration menu appears only if a Model RXT transfer switch is connected.

Use the ATS Configuration submenu to check the Model RXT transfer switch system settings and time delays, and change the settings, if necessary.

Changing ATS Configuration Settings

To enable editing, press the select button. The value flashes to indicate that it can be changed. Press the up and down arrow buttons to change the value. Press the Select button to save the value shown.

Use the up and down arrow buttons to move to the next value to be changed. Repeat the adjustment process until all values are correct.

Press the down arrow until Return is displayed. Press the select button to return to the main menu.

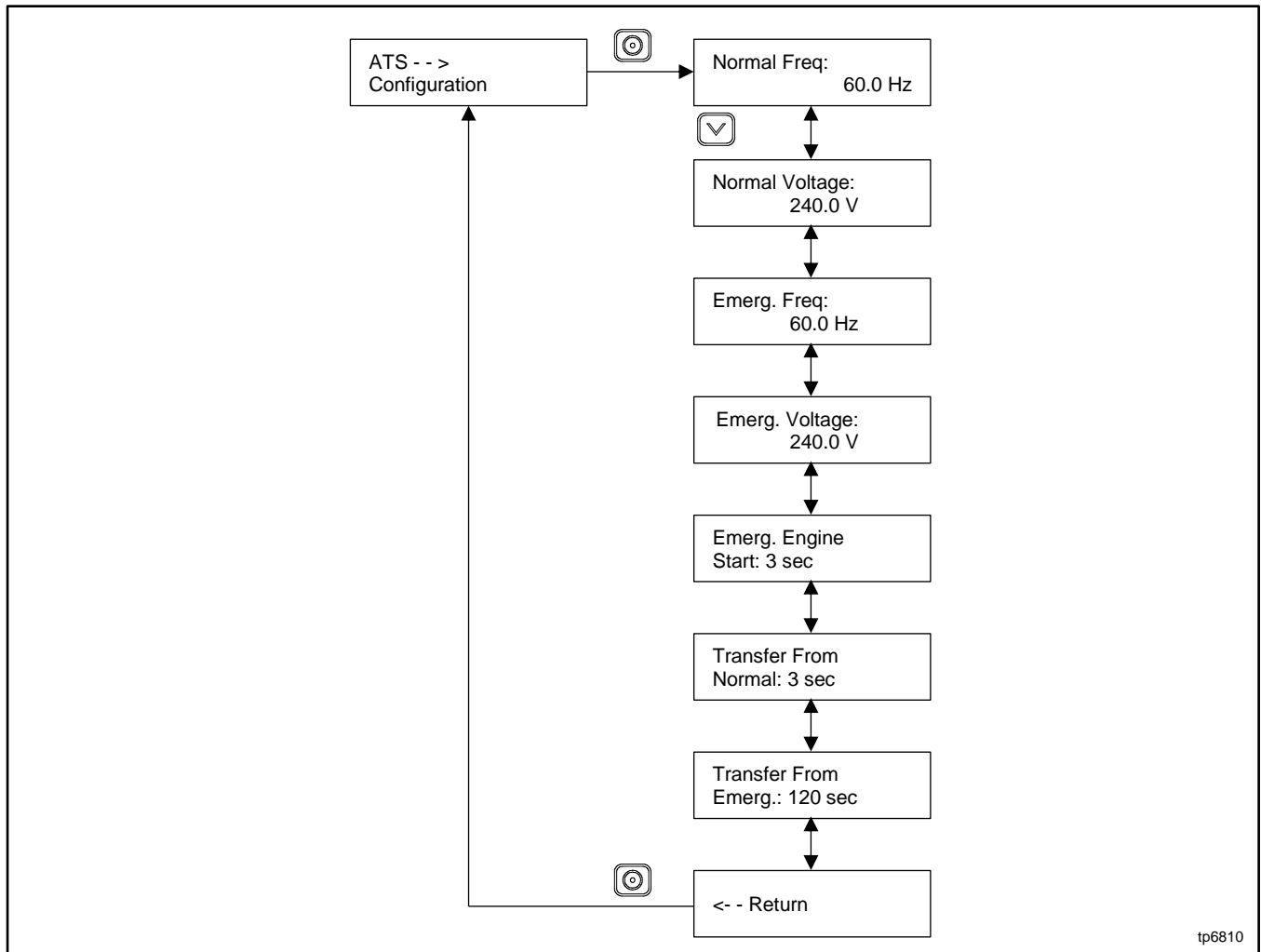

Figure 28 ATS Configuration Menu

3.16 Date and Time Menu

The date and time will typically be set at controller power-up. To change the date, time, or time format (12 hour or 24 hour), use the Date and Time menu. See Figure 29.

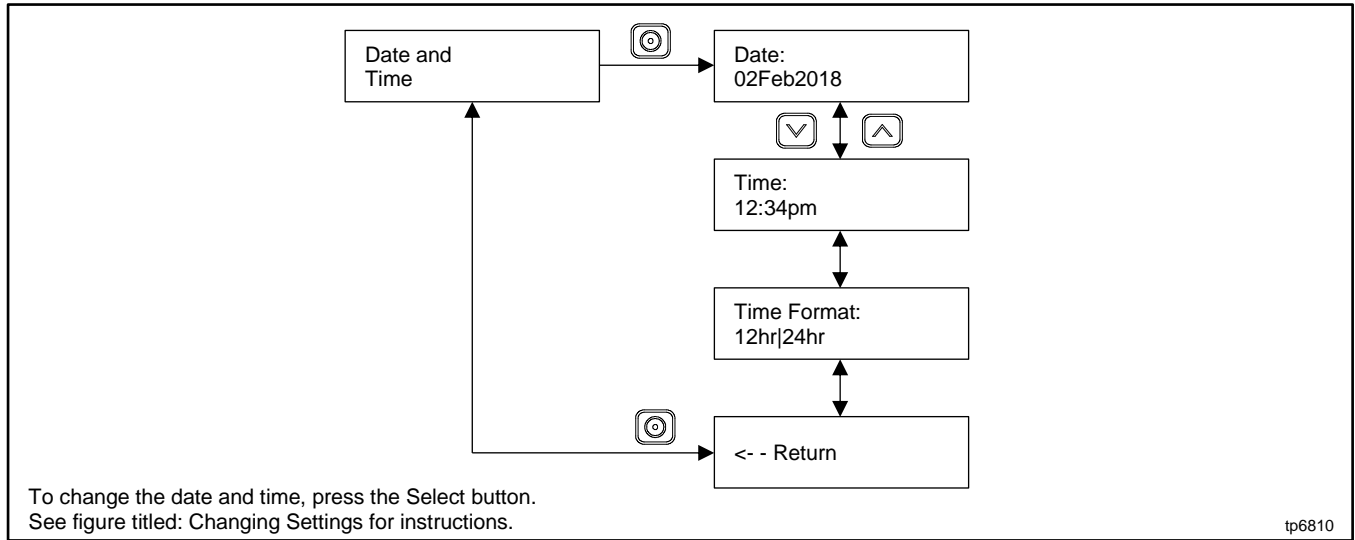

Figure 29 Date and Time Menu

3.17 Networking Information Menus

Use the networking menus to view and adjust communication settings for systems with remote RBUS devices such as a PIM or load management device, and for systems that use the Kohler® OnCue® Plus Home Generator Management System.

The Networking Information menu leads to submenus for network and RBUS communication settings. See Figure 30.

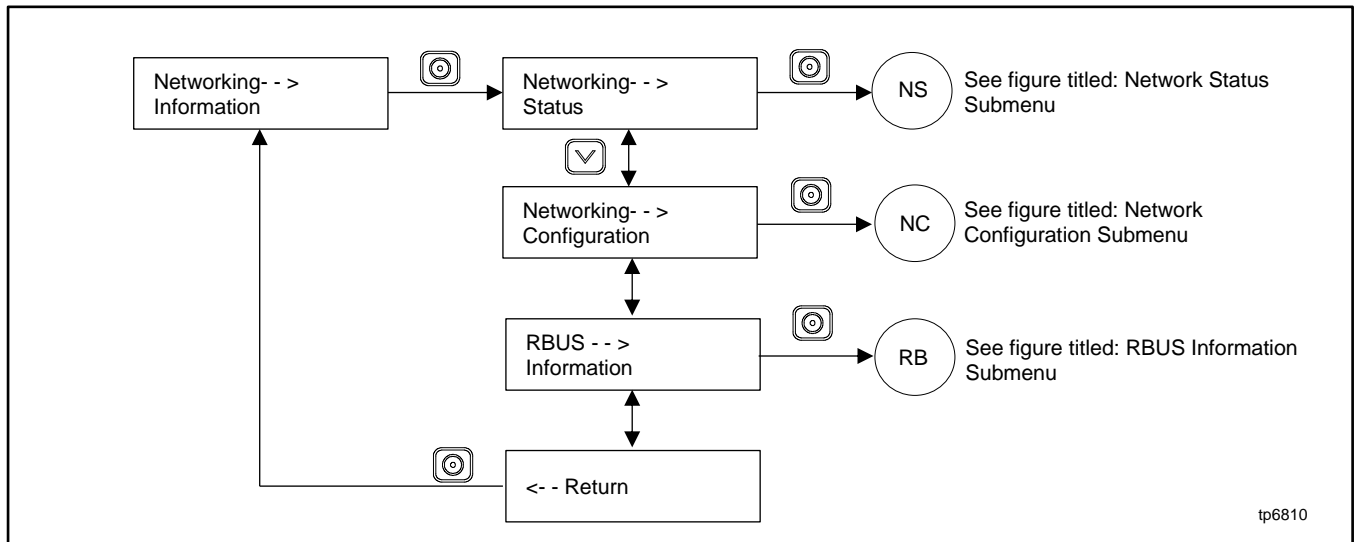

Figure 30 Networking Information Menu

3.17.1 Networking Status Submenu

The Networking Status submenu contains settings for OnCue® Plus. See the OnCue Plus Software Operation Manual for information about the appropriate network settings for OnCue Plus.

If DHCP is enabled, IP parameters are not displayed. If DHCP is disabled (i.e., if a static IP address is used), the IP parameters are displayed.

To enable or disable DHCP and change the IP settings, go to the Networking Configuration menu. See section titled: Networking Configuration Submenu (OnCue Plus Password).

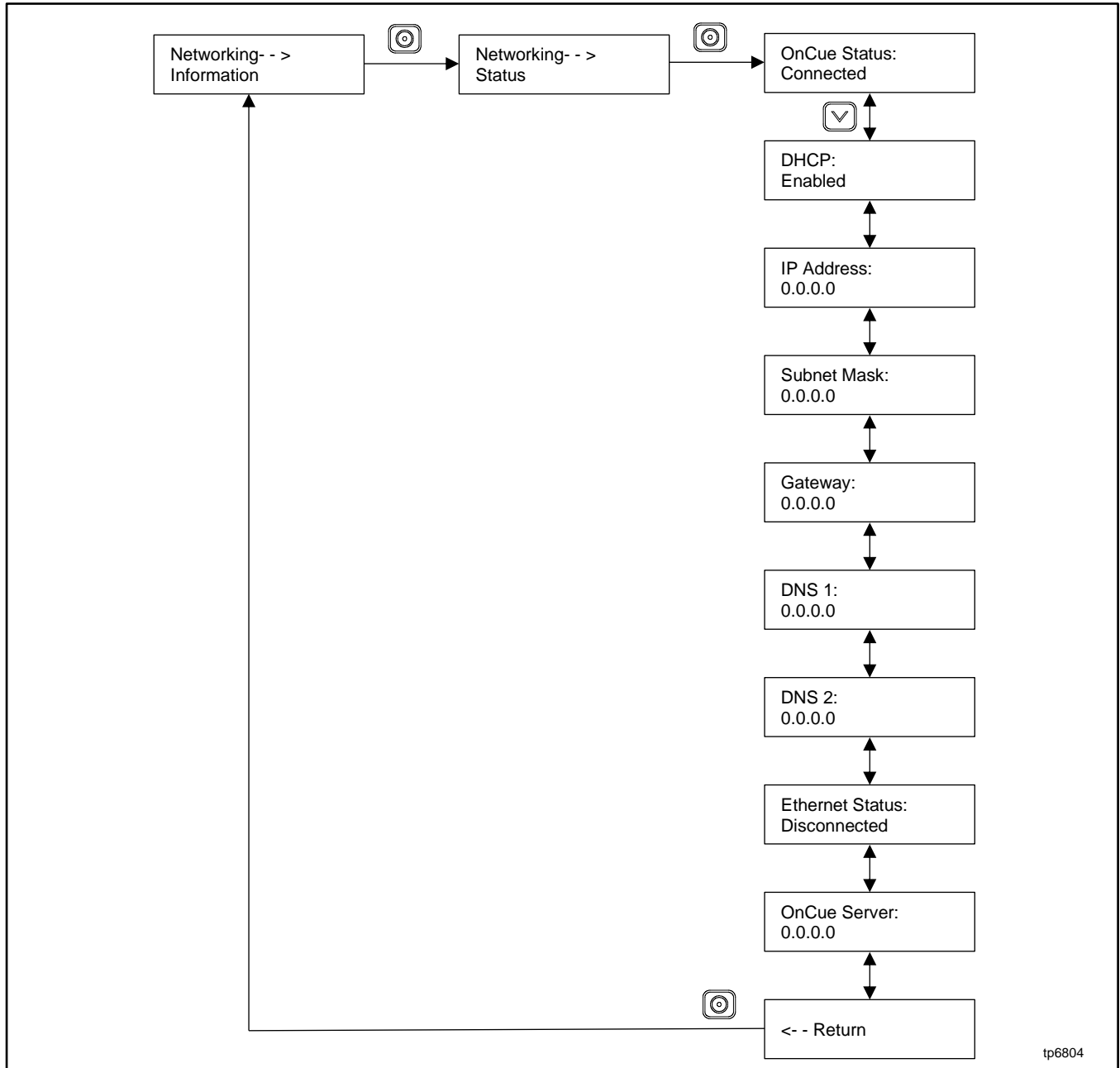

Figure 31 Network Status Submenu

3.17.2 Networking Configuration Submenu (OnCue® Plus Password)

The networking Configuration menu includes settings used for communication with the Kohler® OnCue® Plus Generator Management System.

For most applications, DHCP is enabled and the IP settings cannot be changed from the controller keypad. If DHCP is enabled, IP parameters are not displayed.

If DHCP is disabled (i.e., if a static IP address is required), then the IP parameters can be modified. For applications that require static IP addresses, press and hold the select button to enable editing, disable DHCP, and then step to the next parameters and enter the information.

If an error occurs while setting a parameter, an error message is displayed and then the controller exits the edit mode. Previous settings are preserved.

Note:

Use the OnCue password shown on the controller display for OnCue Plus applications.

For the initial OnCue Plus setup, you will be required to reset the OnCue password on the RDC2 controller, and then enter it into the OnCue Plus software. To reset the password, follow the instructions in Figure 32.

Note:

The password is displayed for only 10 seconds. Be sure to write down the password and serial number.

A new password is generated each time the reset password procedure is performed. If the password is reset after the OnCue Plus system has been set up, the connection will be lost. Disconnect the battery power to the controller, wait a minute, then reconnect power.

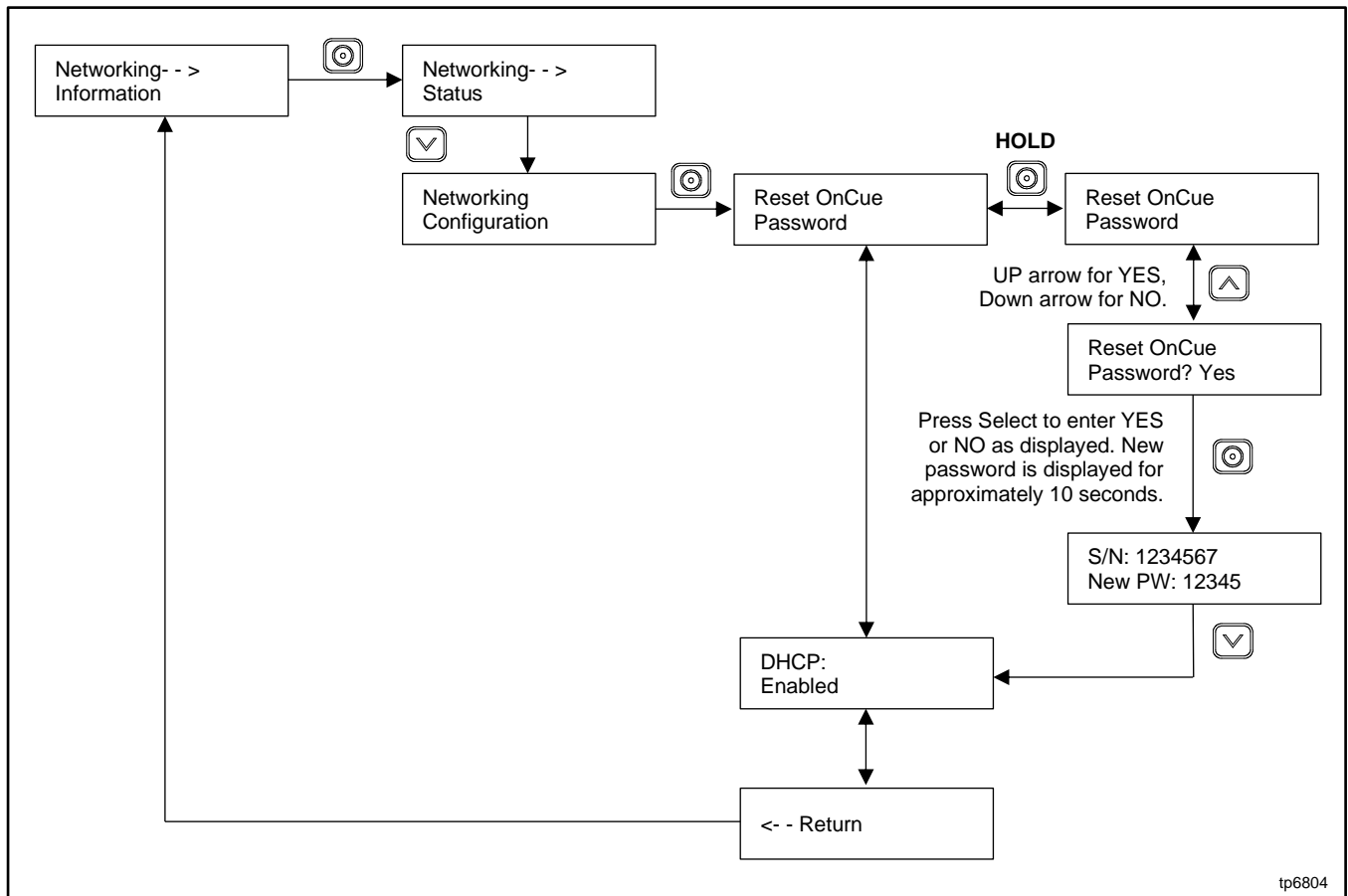

Figure 32 Network Configuration Submenu

3.17.3 RBUS Information Submenu

The RBUS Information menu contains settings for remote modules that communicate with the RDC2 controller using RBUS protocol. This includes the following optional modules:

- Model RXT transfer switch
- Programmable Interface Module (PIM)
- Load Shed Kit or RXT combined interface/load management board

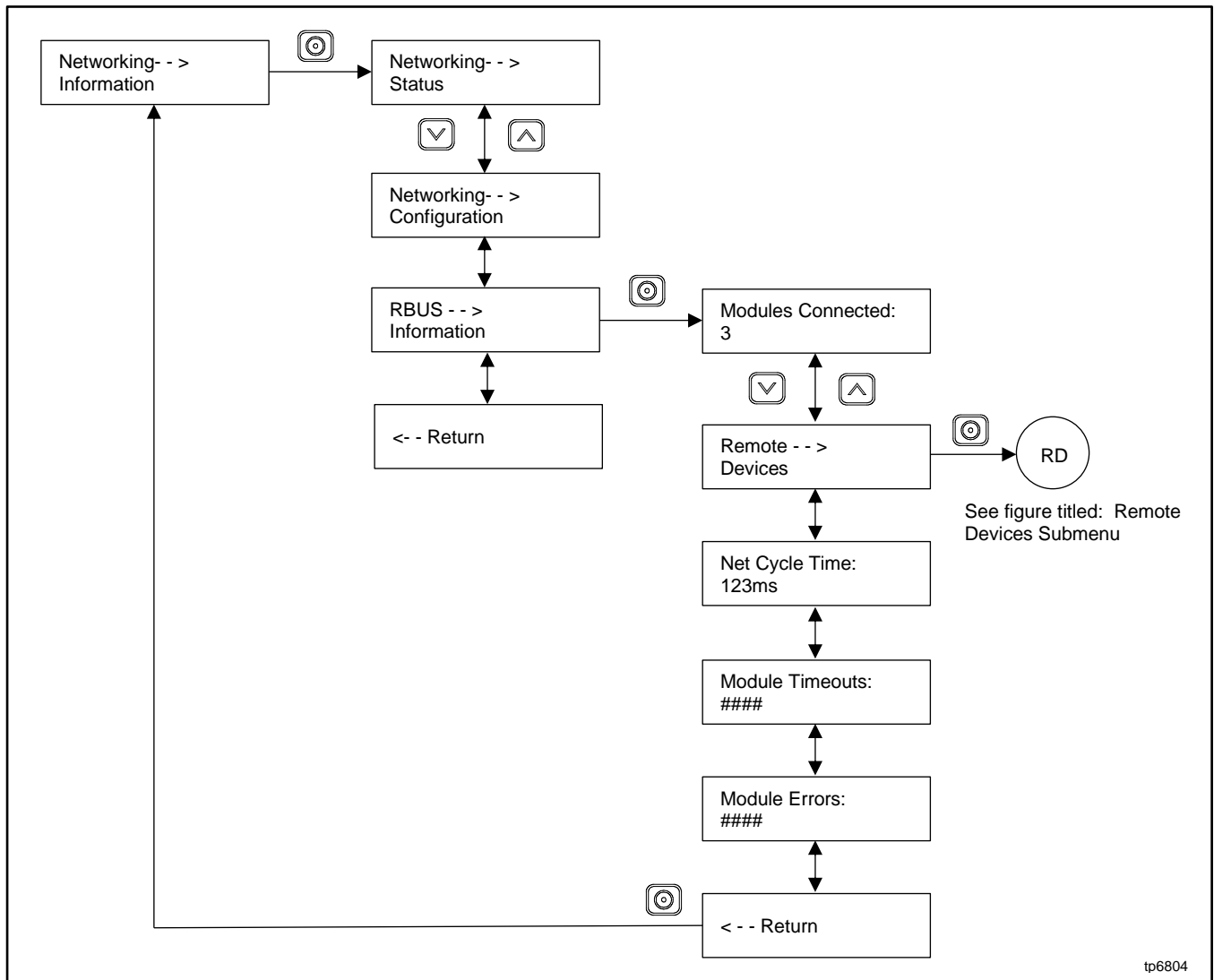

Figure 33 RBUS Information Submenu

tp6804

3.17.4 Remote Devices Submenu

Check the status of remote devices communicating through RBUS. Device types can include:

- Model RXT ATS
- Programmable interface module (PIM)
- Load Shed Kit or RXT combined interface/load management board

The serial numbers for the PIM and load shed kit are printed on the circuit boards inside the enclosures.

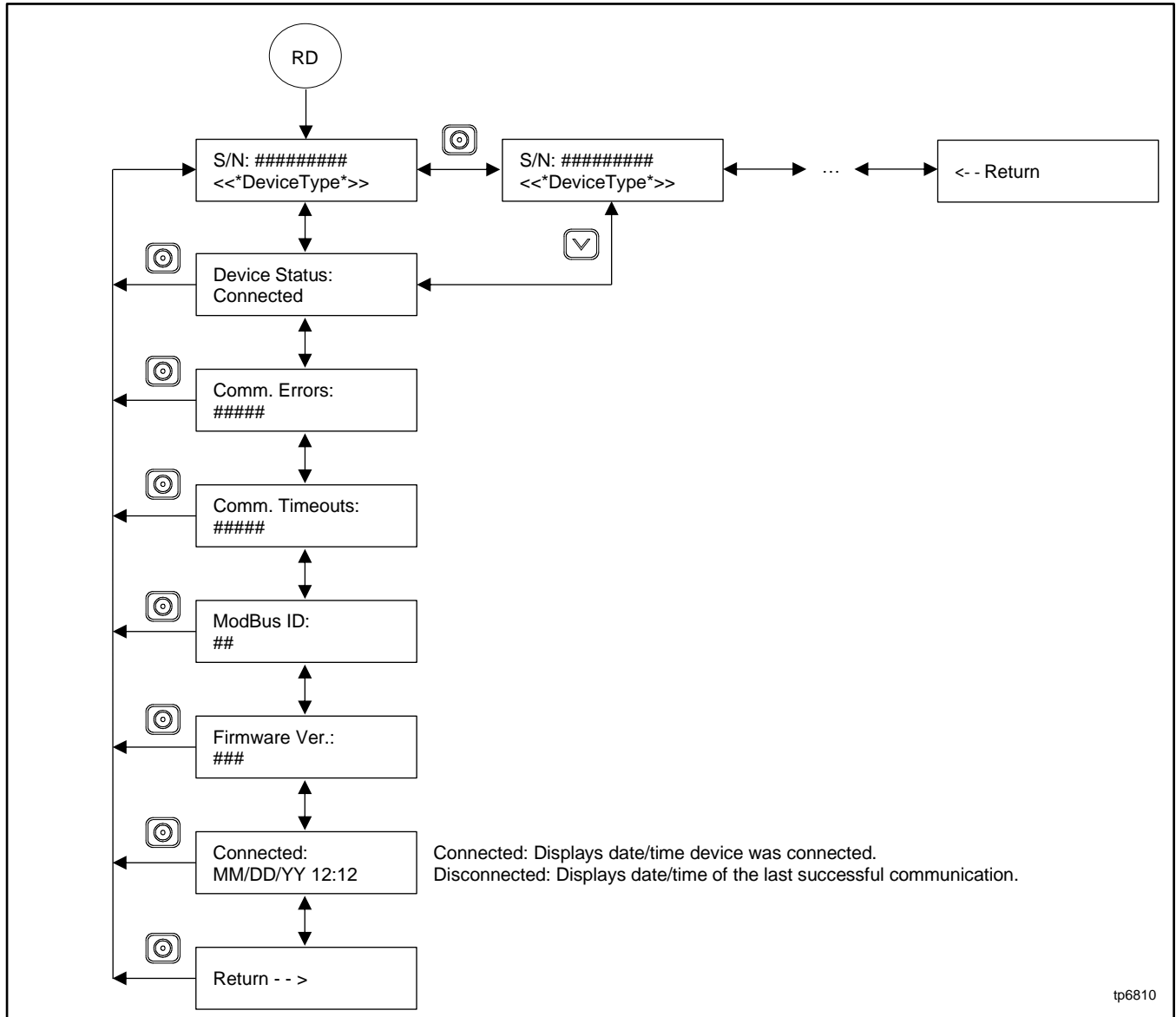

Figure 34 Remote Devices Submenu

3.18 Programmable Interface Module (PIM) Menus

The PIM status menu displays the status of inputs and outputs connected to the programmable interface module (PIM). This is a status display menu only. Input and output settings cannot be changed from the RDC2 controller's user interface.

A personal computer running Kohler® SiteTech™ software is required to change the input and output settings. Contact an authorized dealer for service.

The Kohler® OnCue® Plus Generator Management System can be used to turn outputs on and off. See the OnCue® Plus Software Operation Manual for instructions.

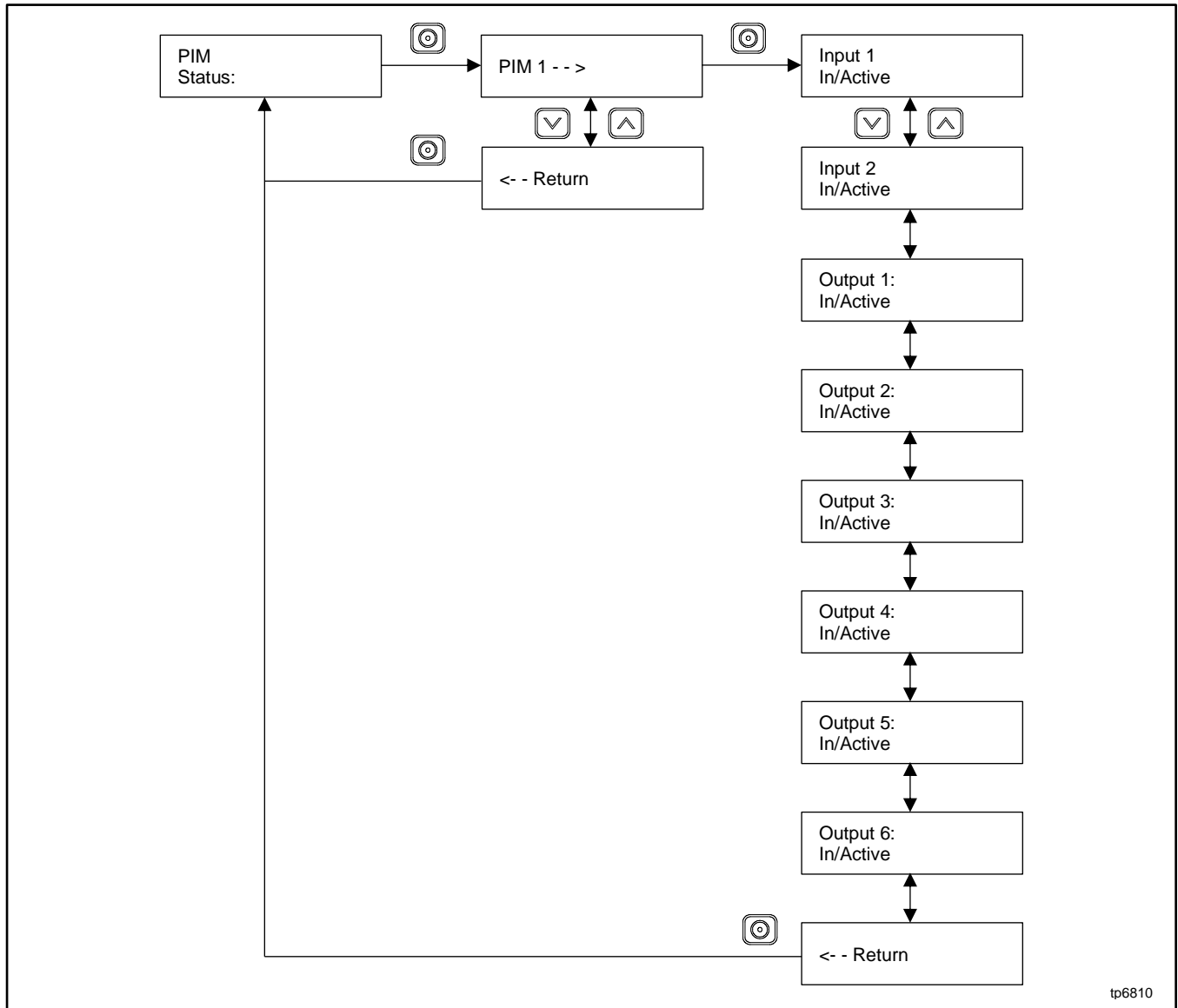

Figure 35 Programmable Interface Module (PIM) Status Menu

3.19 Load Control Menus

The Load Control menu displays the status of the load management inputs and outputs, and allows a test of the load management output relays. This menu appears only if a load management device is connected.

Generator current is displayed as a percent of the maximum generator capacity. The load management device adds and sheds loads based on the generator current.

The test function cycles the relays in the order of their priority. For detailed information about load management operation, refer to the instructions provided with the load shed kit or the RXT Transfer Switch Operation and Installation Manual.

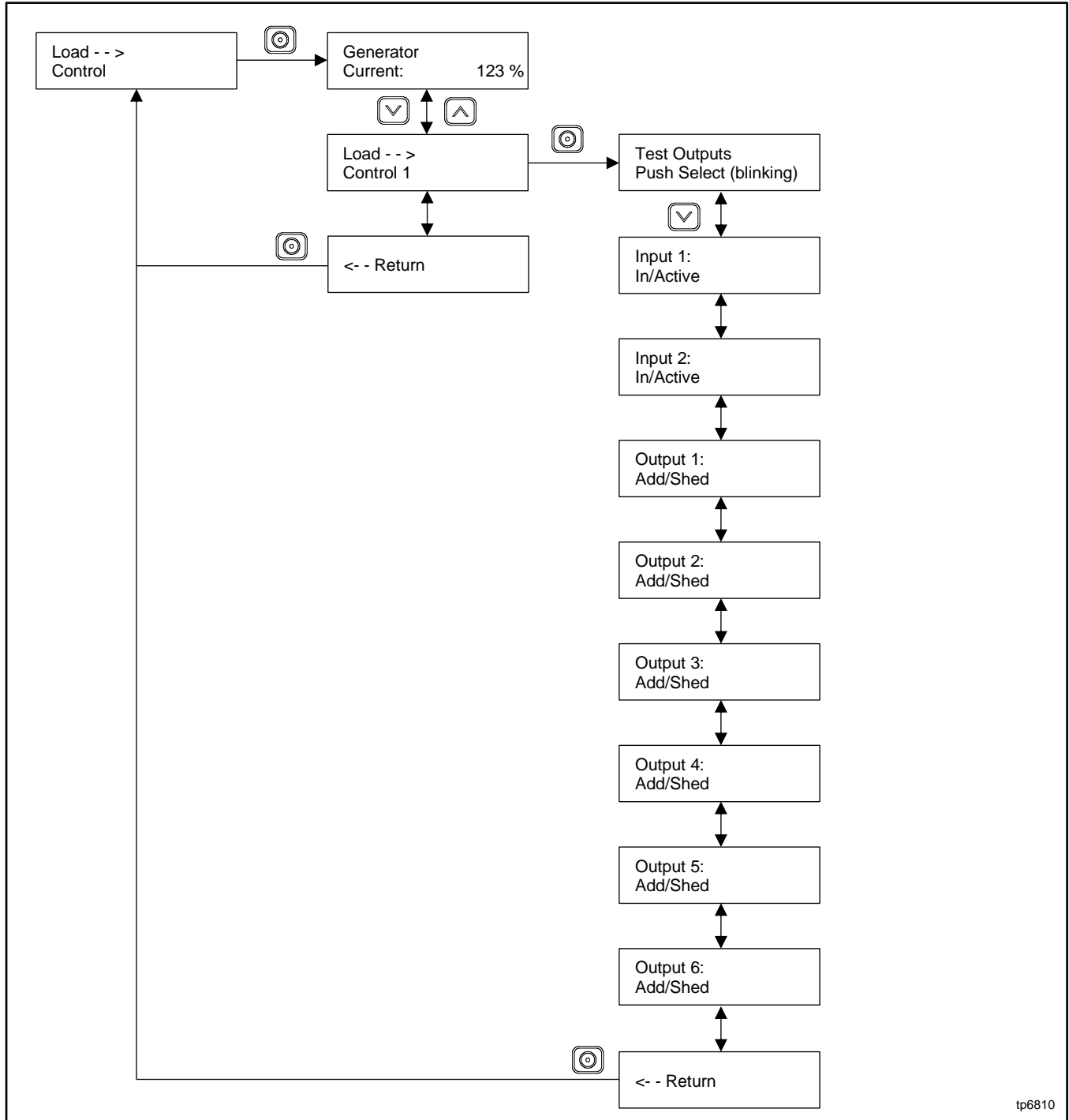

Figure 36 Load Control Status Menu

3.20 Event Log

The event log displays up to 1000 controller faults and notices, starting with the most recent event. Events are numbered 1-1000, with 1 being the most recent. Each event is displayed with the date and time of the event, the number of the event, a code to indicate whether the event was a warning (W), shutdown (S), or informational notice (I), the engine hours at the time of the event, and the event description.

The time and date for notices (I) are not stored in the controller.

Procedure to View Event History

1. Press Select to enter the main menu.
2. Press the down arrow to step down to the event log.
3. Press Select to display the most recent event.
4. Press the down arrow to step to the next event.
5. Use the up and down arrow buttons to view events.
6. Press the Select button to exit the event log.

To stop viewing the event history before the last event, press the select button to return to the main menu.

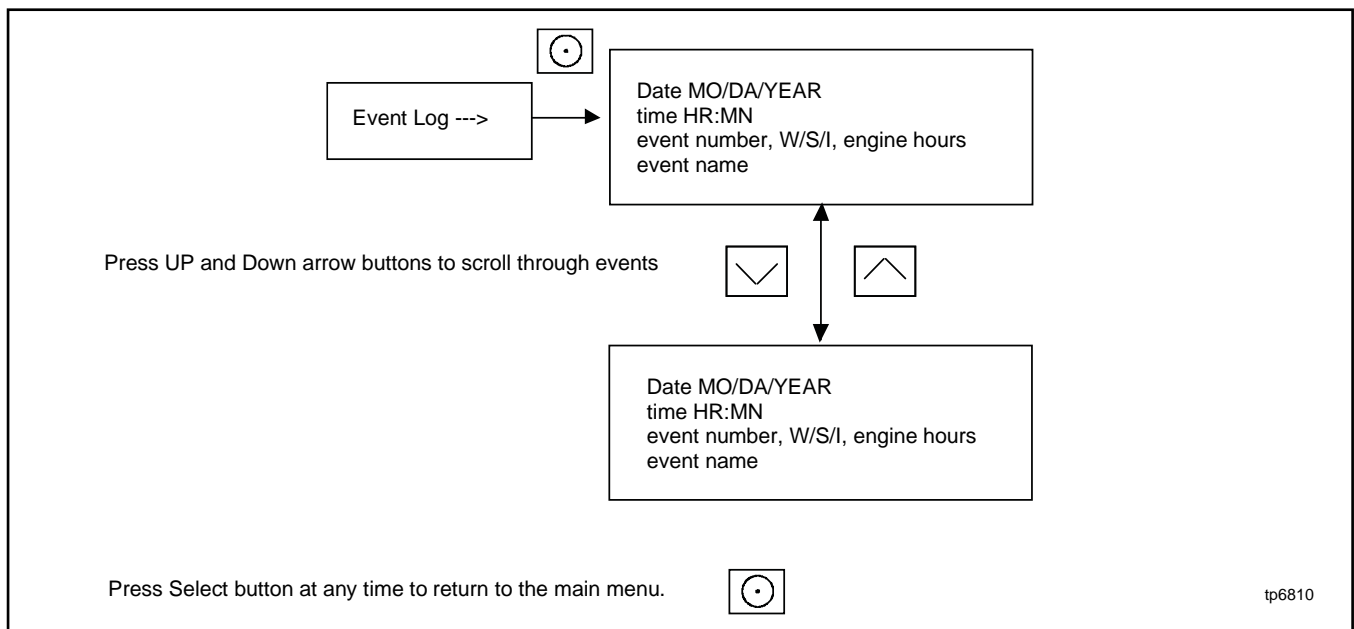





Figure 37 Event Log

4.1 Introduction

Accessories are available factory-installed and/or shipped loose. Obtain the most current list of accessories from the generator set specification sheet or by contacting an authorized Kohler dealer. Have accessories installed by your local authorized Kohler dealer or authorized representative.

The following sections list some common accessories and their functions.

 DANGER	Hazardous voltage. Will cause severe injury or death. Disconnect all power sources before opening the enclosure.
	
 WARNING	Hot engine and exhaust system. Can cause severe injury or death. Do not work on the generator set until it cools.
	

4.2 Battery Heaters

Battery heater kits are available to help increase the battery temperature in cold climates. The battery heater kit includes a heating battery wrap and a thermostat for controlled heating.

The heater requires a 120 VAC, 15 amp. electrical outlet within reach of the power cord for each battery heater wrap. The circuit must be backed up by the generator set to provide power at all times.

Note:

Battery heaters are compatible with all Kohler-supplied lead-acid batteries. For other battery types, check the battery manufacturer's instructions for any restrictions regarding the use of battery heaters.

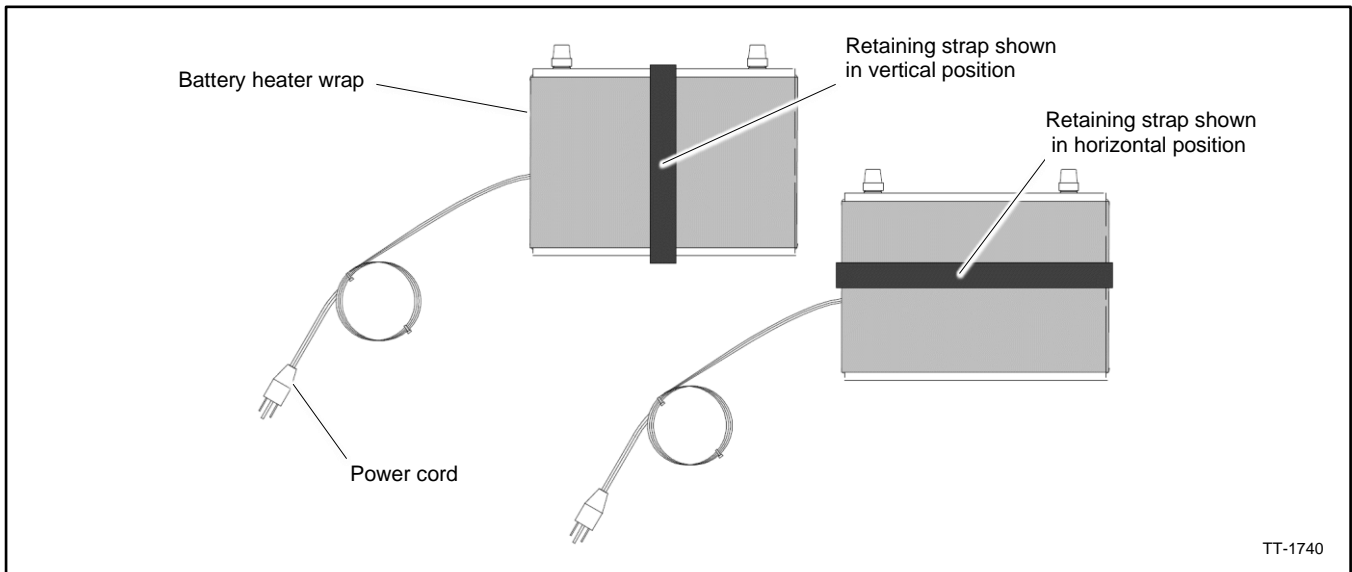

Figure 38 Typical Battery Heater

4.3 Block Heaters

Block heaters are available as loose accessories. Use block heaters on standby applications where the generator set is frequently subjected to temperatures below 0°C (32°F). The engine block heater kit heats the engine coolant, making starting easier and warmup quicker. The thermostat, built into the base of the block heater, automatically turns off the heater when coolant temperature reaches 27 to 38°C (80 to 100°F).

Connect the block heater to a power circuit that is backed up by the generator set to provide power at all times.

Note:

Block heater damage. The block heater will fail if the energized heater element is not immersed in coolant. Fill the cooling system before turning on the block heater. Run the engine until it is warm and refill the radiator to purge the air from the system before energizing the block heater.

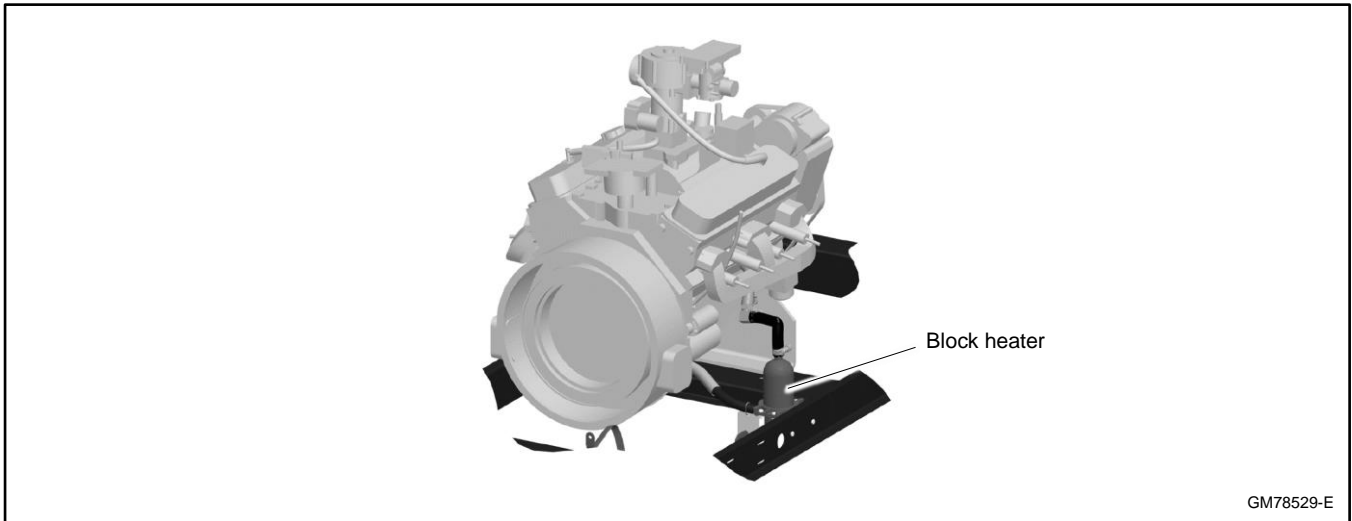

Figure 39 Block Heater (typical location)

4.4 Emergency Stop Kits

The emergency stop (E-stop) switch allows immediate shutdown of the generator set from a remote location. The E-stop assembly includes a shroud that allows the installation of a lockout/tagout device to lock the switch in the stop position. See Figure 40.

Emergency stops kits are available for mounting on the generator enclosure and for remote mounting. Multiple switches may be connected in series to ensure that activating any one of the stop switches will stop the generator set.

Operation

Press the red STOP button to shut down the generator set in an emergency. Using the emergency stop button bypasses the engine cooldown cycle, stopping the engine immediately. The controller displays an emergency stop shutdown message and the unit shuts down. The generator set cannot be restarted until the emergency stop switch(es) is/are reset.

Lockout/Tagout

The emergency stop button can be locked in the STOP position. Insert a lock through two openings in the yellow shroud to prevent the stop button from being pulled out. Remove the lock for normal operation. A lock is not required in order to keep the switch activated. The switch button will stay depressed until it is pulled out by the operator.

Resetting the Emergency Stop Switch

To reset the E- stop switch, remove the locking device and pull the button out. Reset the controller by pressing the OFF/RESET button.

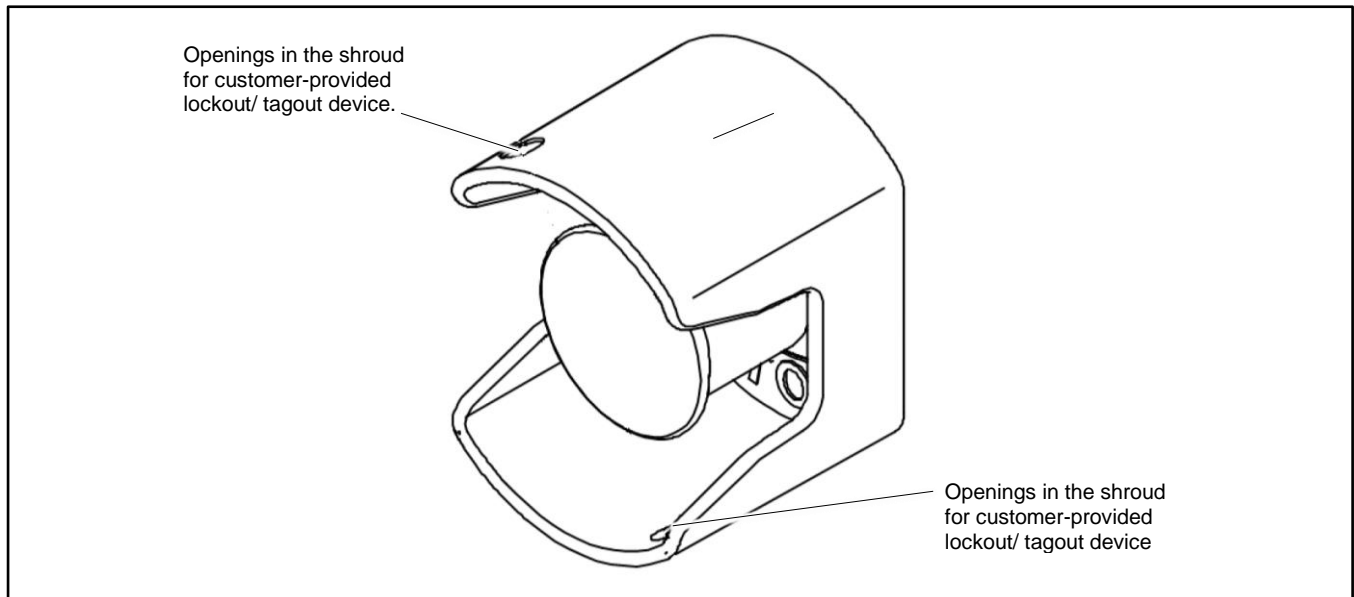

Figure 40 Emergency Stop Switch (typical)

4.5 Dual Fuel Automatic Changeover Kit with Reset Box

Some applications use natural gas as the primary fuel and LP gas as the emergency fuel when natural gas is not available. The optional automatic changeover dual fuel system allows the system to switch to LP fuel automatically if the natural gas supply is not available.

The dual fuel natural gas and LP gas system contains a separate secondary gas regulator and dual solenoid valve for each fuel. A pressure switch on the primary fuel source closes when fuel pressure drops, which energizes a relay that closes the primary fuel solenoid and opens the secondary or emergency fuel solenoid.

The dual fuel reset box includes:

- An indicator light that turns on when the system is using LP fuel.
- A reset switch that allows manual return to natural gas, if available.

Once on LP, the fuel system will switch back to natural gas when:

- The LP fuel supply runs out; or
- The generator set stops and restarts; or
- The reset switch on the dual fuel box is used.

Procedure to Reset to Natural Gas

To reset the fuel to natural gas using the reset box, turn the reset switch clockwise and hold it briefly until the changeover occurs. The indicator light turns off when the system has changed back to natural gas.

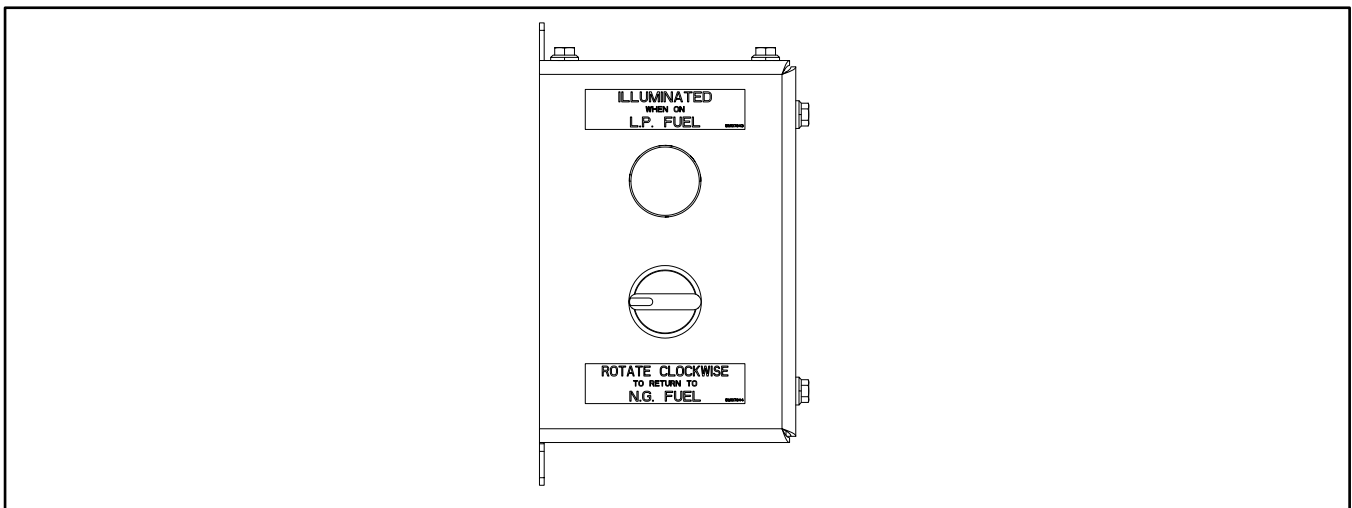

Figure 41 Dual Fuel Reset Box

4.6 OnCue Plus Generator Management System

The Kohler OnCue Plus Generator Management System is now included with the generator set. The OnCue Plus System allows monitoring and control of your generator set from your home or other location with Internet access using a computer or mobile device. OnCue Plus can be configured to send email or text message notifications in the event of a generator set fault.

You can also use Google Assistant or Amazon Alexa and your smart device to control your generator. Use voice commands to check your generator's status, check for active alerts, and start or stop an exercise. See the OnCue Plus User Guide, TP- 7006, for simple setup instructions and voice commands.

OnCue Plus Wireless is also available. OnCue Plus Wireless works with the customer's wireless Ethernet router and does not require the installation of a network cable between the generator set and the customer's router/modem.

4.7 Load Management

Two optional load management devices are available for use with single-phase generator sets and a model RXT or RDT transfer switch:

- The optional Load Shed Kit mounts inside a model RDT or RXT transfer switch.
- The combined interface/load management board is available for the Model RXT transfer switch.

The load management devices provide an automatic load management system to comply with Section 702.5 of NEC 2008.

Note:

The load management devices are only compatible with single-phase generator sets.

With a load management system, less critical appliances can be powered by the generator set when the more important appliances are not running, allowing the use of a smaller generator set than would be needed to run all of the building's electrical equipment at the same time.

The load management device automatically manages up to six residential loads.

- Two relays are included to control two independent heating, ventilation, and air conditioning (HVAC) loads.
- Up to four power relay modules can be connected through normally open relay contacts on the circuit board. Power relay modules are available separately.

The load management device receives commands from the RDC2 generator controller and energizes or de-energizes the appropriate load relays to add or shed non-critical loads according to their priority.

Note:

Connect only non-essential loads to the load shed kit.

The load management device automatically manages up to six residential loads. Two relays are provided to control two independent air conditioner loads. Up to four power relay modules can be connected for management of non-essential secondary loads.

4.8 Programmable Interface Module (PIM)



The optional Programmable Interface Module (PIM) provides two programmable inputs and six programmable dry contact outputs for connection to customer-supplied equipment. The outputs are controlled by the RDC2 controller, and can also be controlled remotely using OnCue Plus.

The PIM is mounted in a NEMA 3R aluminum enclosure, which can be mounted indoors or outdoors. See the installation instructions provided with the PIM for more information.



Notes

Section 5. Scheduled maintenance

5.1 General Maintenance

 WARNING	Accidental starting. Can cause severe injury or death. Disconnect the battery cables before working on the generator set. Remove the negative (-) lead first when disconnecting the battery. Reconnect the negative (-) lead last when reconnecting the battery.
	



Disabling the generator set. Accidental starting can cause severe injury or death. Before working on the generator set or equipment connected to the set, disable the generator set as follows: (1) Press the generator set off/reset button to shut down the generator set. (2) Disconnect the power to the battery charger, if equipped. (3) Remove the battery cables, negative (-) lead first. Reconnect the negative (-) lead last when reconnecting the battery. Follow these precautions to prevent the starting of the generator set by the remote start/stop switch.



 WARNING	Hot engine and exhaust system. Can cause severe injury or death. Do not work on the generator set until it cools.
	

Servicing the exhaust system. Hot parts can cause severe injury or death. Do not touch hot engine parts. The engine and exhaust system components become extremely hot during operation.

Servicing the alternator. Hot parts can cause severe injury or death. Avoid touching the alternator field or exciter armature. When shorted, the alternator field and exciter armature become hot enough to cause severe burns.

Servicing the engine heater. Hot parts can cause minor personal injury or property damage. Install the heater before connecting it to power. Operating the heater before installation can cause burns and component damage. Disconnect power to the heater and allow it to cool before servicing the heater or nearby parts.

 DANGER	Hazardous voltage. Will cause severe injury or death. Disconnect all power sources before opening the enclosure.
	

 DANGER	Hazardous voltage. Moving parts. Will cause severe injury or death. Operate the generator set only when all guards and electrical enclosures are in place.
	

Servicing the generator set when it is operating. Exposed moving parts will cause severe injury or death. Keep hands, feet, hair, clothing, and test leads away from the belts and pulleys when the generator set is running. Replace guards, screens, and covers before operating the generator set.

 WARNING	Risk of fire. Can cause severe injury or death. Do not smoke or permit flames or sparks near fuels or the fuel system.
	

Servicing the air cleaner. A sudden backfire can cause severe injury or death. Do not operate the generator set with the air cleaner removed.

Servicing the fuel system. A flash fire can cause severe injury or death. Do not smoke or permit flames or sparks near the carburetor, fuel line, fuel filter, fuel pump, or other potential sources of spilled fuels or fuel vapors. Catch fuels in an approved container when removing the fuel line or carburetor.

The fuel system. Explosive fuel vapors can cause severe injury or death. Vaporized fuels are highly explosive. Use extreme care when handling and storing fuels. Store fuels in a well-ventilated area away from spark-producing equipment and out of the reach of children. Never add fuel to the tank while the engine is running because spilled fuel may ignite on contact with hot parts or from sparks. Do not smoke or permit flames or sparks to occur near sources of spilled fuel or fuel vapors. Keep the fuel lines and connections tight and in good condition. Do not replace flexible fuel lines with rigid lines. Use flexible sections to avoid fuel line breakage caused by vibration. Do not operate the generator set in the presence of fuel leaks, fuel accumulation, or sparks. Repair fuel systems before resuming generator set operation.

Gas fuel leaks. Explosive fuel vapors can cause severe injury or death. Fuel leakage can cause an explosion. Check the LPG vapor or natural gas fuel system for leakage by using a soap and water solution with the fuel system test pressurized to 6–8 ounces per square inch (10–14 inches water column). Do not use a soap solution containing either ammonia or chlorine because both prevent bubble formation. A successful test depends on the ability of the solution to bubble.

The engine and generator set may use both American Standard and metric hardware. Use the correct size tools to prevent rounding of the bolt heads and nuts.

Utility power is connected to the generator set for battery charging and optional accessories. Disconnect the utility power before servicing the generator set. Typically, the utility power can be disconnected by opening a circuit breaker in the customer's electrical distribution box.

See the Safety Precautions and Instructions at the beginning of this manual before attempting to service, repair, or operate the generator set. **Have an authorized Kohler dealer or service technician perform generator set service.**

Engine Service. Perform generator set engine service at the intervals specified by the engine operation manual.

Generator Set Service. Perform generator set service at the intervals specified by the generator set operation manual.

Routine Maintenance. Refer to the following generator set service schedule, the engine service schedule, and the runtime hours shown on the RDC2 controller to determine when to schedule routine maintenance. Service generator sets that are subject to extreme weather or dusty or dirty conditions more frequently.

Maintenance and Service Parts. Obtain maintenance and service parts from an authorized Kohler dealer.

5.2 Service Schedule

Perform maintenance on each item in the service schedule at the designated intervals for the life of the generator set. References are given for procedures that may require additional instructions.

Service Schedule	Reference
Daily or Before Each Use	
Check oil level and add oil if necessary.	Lubrication System Section
Check coolant level and add coolant if necessary. §	Cooling System Section
Check for fluid leaks.	
Check battery connections for tightness and signs of corrosion.	Battery Section
Check for fuel leaks, hissing, or gas odors.	
Weekly	
Check main tank supply level (LPG fuel).	
Check for and remove obstructions or combustible materials near exhaust outlet.	Exhaust System Section
Check for and remove obstructions near air intake.	
Check AC electrical system for visible wear or damage.	
Exercise the generator set.	Exercising the Generator Set and Exercise Section
Check for evidence of vibration, leakage, deterioration, unusual or excessive noise or temperature.	
Monthly	
Check battery charger operation, charge rate.	
Quarterly (3 Months)	
Remote control system, if equipped.	
Check fuel lines and connections.	
Check engine and generator for visible wear or damage.	
Check interior of sound enclosure.	
Every 6 Months	
Check for wire abrasions where subject to motion.	
Yearly	
Inspect fuel piping.	
Check and clean the radiator exterior.	
Remove corrosion, clean and dry battery and rack.	Battery Section
Clean and tighten battery terminals and inspect boots.	Battery Section
Check battery electrolyte level and specific gravity. *	Battery Section
Tighten control and power wiring connections.	
Check the DEPR fuel pressure.	Engine Operation Manual
Check the drive belt for cracks, splitting, or breaks.	Engine Operation Manual
Yearly or 150 hours	
Change engine oil and replace oil filter.	Lubrication System Battery Section
Inspect crankcase breather hose.	Engine Operation Manual
Check spark plugs.	Spark Plugs Section
Check the air cleaner element. †	Air Cleaner Section
Yearly or 400 hours	
Replace the air cleaner element. †	Air Cleaner Section
3 Years or 500 hours	
Check engine air induction system for leaks.	
Check spark plug gap and adjust if necessary. Replace spark plugs if discolored or damaged.	Spark Plugs Section
Check spark plug wires for cuts, hardening or abrasions and replace as needed.	
Check wire-cable insulation condition.	
Change the engine coolant. §	Cooling System Section
Measure and record resistance readings of windings with insulation tester (Megger®, with SCR assembly or rectifier and load leads disconnected). ‡	Generator Set Service Manual
1000 hours	
Replace spark plugs.	Spark Plugs Section
5 Years or 2000 hours	
See the Engine Operation Manual for engine maintenance requirements.	Engine Operation Manual
* Not necessary for maintenance-free batteries. † Service more frequently under extremely dusty/dirty conditions. ‡ Have this service performed by an authorized dealer. § Long-life coolant is recommended. When long-life coolant is used, the change interval is 5000 hours or 5 years. Do not mix coolant types. Megger® is a registered trademark of Biddle Instruments.	

5.3 Lubrication System

5.3.1 Oil Specifications

Kohler recommends KOHLER® Genuine Oil, 10W-40 or equivalent.

KOHLER® Genuine Oil is fully synthetic and engineered specifically for gaseous-fueled (NG/LPG) engines requiring SAE 10W-40 oil.

Note:

The oil must meet the specifications for zinc, phosphorous, and ash content shown in Figure 42.

Oil Specifications	
Oil Type	SAE 10W-40
Zinc Content	1000- 1200 ppm
Phosphorous	1000- 1200 ppm
Sulfated Ash Content	1% or lower

Figure 42 Engine Oil Specifications

5.3.2 Oil Check

Check the oil level in the crankcase every 24 hours of operation or before the engine is started each day. Do not check the oil level while operating the unit. Stop the generator set and keep the generator set level to get an accurate reading. To check the oil level, remove the dipstick and wipe the end clean. Reinsert the dipstick and wait at least 30 seconds. Remove the dipstick and check the level. Maintain the oil level between the Full and Add marks on the dipstick, as shown in Figure 43. See the Service Views for the dipstick location.

Note:

Do not operate the set if the oil level is below the Add mark or above the Full mark on the dipstick.

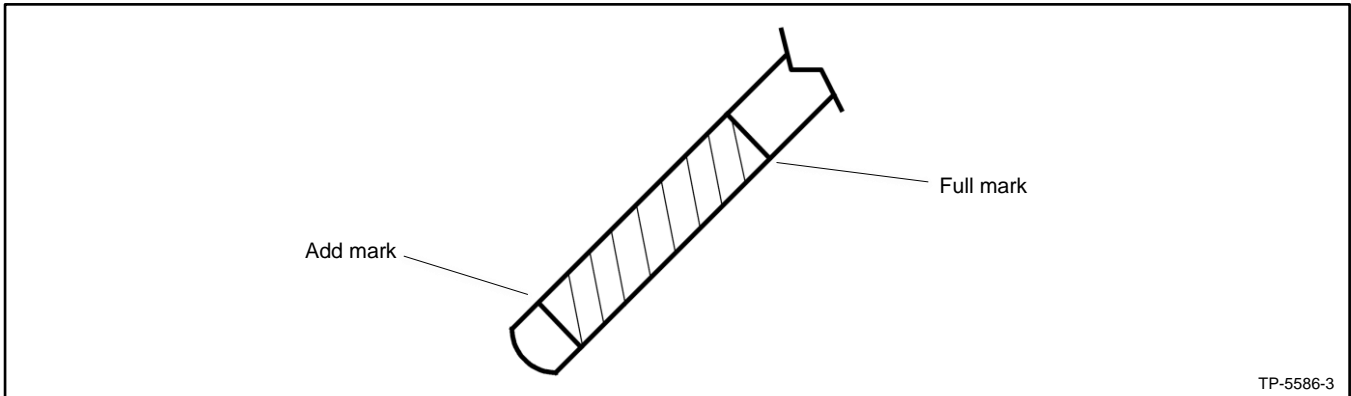





Figure 43 Oil Level Check

5.3.3 Oil Additions

Adding some oil between oil changes is normal. The amount varies with generator set usage. Open the oil fill cap and pour in a small amount of oil using a funnel or other suitable pouring device. See the Service Views for the oil check and oil fill locations.

5.3.4 Oil and Filter Change

 WARNING	Accidental starting. Can cause severe injury or death. Disconnect the battery cables before working on the generator set. Remove the negative (-) lead first when disconnecting the battery. Reconnect the negative (-) lead last when reconnecting the battery.
  	

Disabling the generator set. Accidental starting can cause severe injury or death. Before working on the generator set or equipment connected to the set, disable the generator set as follows: (1) Press the generator set off/reset button to shut down the generator set. (2) Disconnect the power to the battery charger, if equipped. (3) Remove the battery cables, negative (-) lead first. Reconnect the negative (-) lead last when reconnecting the battery. Follow these precautions to prevent the starting of the generator set by the remote start/stop switch.

Change the oil every 150 hours of engine operation, as shown in the service schedule, or before generator set storage. Change the oil more frequently if the generator set operates under dirty, dusty conditions. Change the oil while the engine is still warm. See the Service Views for oil fill, oil check, and oil filter locations.

Note:

The engine is shipped from the factory with break-in oil. Run the engine for a minimum of 40 hours with the break-in oil. Change the break-in oil according to the normal service schedule, after 150 hours of engine operation.

Dispose of all waste materials (engine oil, fuel, filter, etc.) in an environmentally safe manner.

Note:

Reset the maintenance timer on the RDC2 controller after changing the oil.

Oil Change Procedure

Whenever possible, drain the oil while it is still warm.

1. Drain the oil.

- a. Press the OFF button on the RDC2 generator set controller.
- b. Utility power is connected to the generator set for battery charging and optional AC accessories. Disconnect the power from the generator set.
- c. Disconnect the generator set engine starting battery, negative (-) lead first.
- d. Remove the housing side panel.
- e. Remove the plug from the oil drain fitting and install a drain hose.
- f. Open the oil drain valve on the engine.
- g. Allow time for the engine oil to drain completely.
- h. Close the oil drain valve.
- i. Replace the oil drain plug.

2. Replace the oil filter.

- a. Remove the oil filter by rotating it counterclockwise with an oil filter wrench.
- b. Clean any surfaces that the oil filter contacts.
- c. Apply a light coat of clean oil to the gasket of the new oil filter.
- d. Lightly turn the new oil filter by hand until you feel resistance. Then, tighten the filter an additional 3/4 turn with an oil filter wrench [Torque = 25 Nm (18.4 ft. lbs.)].

3. **Fill with oil.** Use **5W-30** for oil selection and Figure 44 for oil capacity.

Models	Oil Capacity, L (qt.)
48RCLB/C and 60RCLA/B	4.7 (5.0)

Figure 44 Oil Capacity

4. **Check for leaks.**

- a. Press the OFF button on the RDC2 generator set controller.
- b. Reconnect the generator set engine starting battery, negative (-) lead last.
- c. Reconnect the power for the battery charger.
- d. Start the generator set and check for leaks around the oil filter.
- e. Stop the generator set and tighten the oil filter to stop any leaks.
- f. Reinstall the housing side panel.

4. **Stop the generator set.** Check the oil level. Add oil, as necessary, to bring the level up to the Full mark.



Note:

Too high an oil level causes high oil consumption and engine carbonizing. Too low a level damages the engine.



5. **Reset the maintenance timer on the RDC2.**

- a. In the Overview menu, step down to the Genset Run Time menu.
- b. Press the Select button and then step down to the Next Maintenance screen.
- c. Press the Select button.
- d. Press the Up arrow button so that Reset Main Timer? Yes is displayed.

5.4 Air Cleaner

 WARNING	<p>Accidental starting. Can cause severe injury or death.</p> <p>Disconnect the battery cables before working on the generator set. Remove the negative (-) lead first when disconnecting the battery. Reconnect the negative (-) lead last when reconnecting the battery.</p>
	

Disabling the generator set. Accidental starting can cause severe injury or death. Before working on the generator set or equipment connected to the set, disable the generator set as follows: (1) Press the generator set off/reset button to shut down the generator set. (2) Disconnect the power to the battery charger, if equipped. (3) Remove the battery cables, negative (-) lead first. Reconnect the negative (-) lead last when reconnecting the battery. Follow these precautions to prevent the starting of the generator set by the remote start/stop switch.

 WARNING	<p>Risk of fire. Can cause severe injury or death.</p> <p>Do not smoke or permit flames or sparks near fuels or the fuel system.</p>
	

Servicing the air cleaner. A sudden backfire can cause severe injury or death. Do not operate the generator set with the air cleaner removed.

At the interval specified in the Service Schedule Section, inspect and clean or replace the air cleaner element. Clean the element more frequently in dirty, dusty conditions. Check the element for accumulated oil or dirt that could cause poor performance. Replace a damaged air cleaner element. Follow the procedure described below.

Air Cleaner Service Procedure

A dry-type air cleaner silences and filters the intake air. The air intake silencer assembly connects to the intake manifold via a rubber hose. Refer to Figure 45 during this procedure.

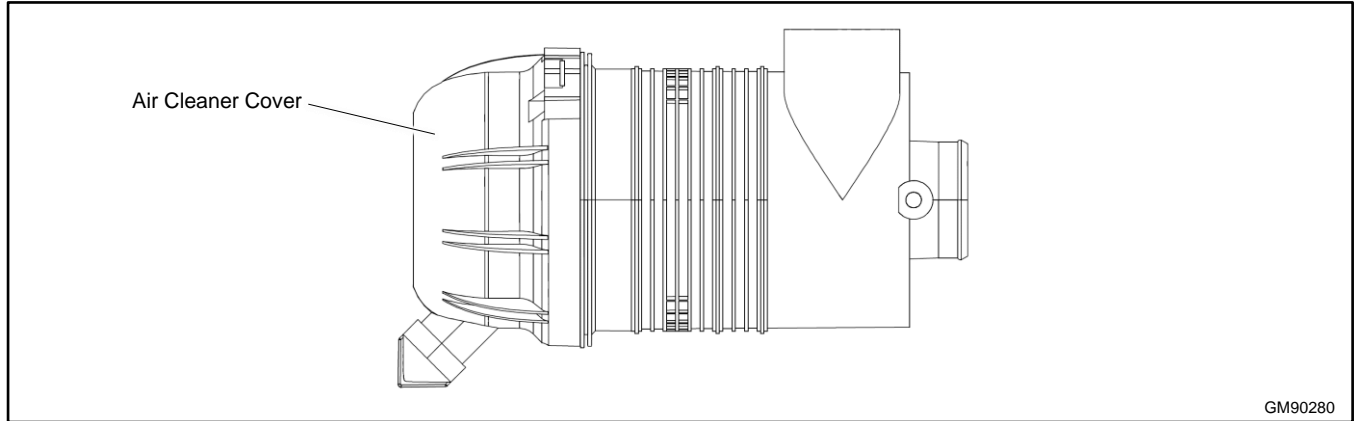



Figure 45 Air Cleaner

1. Press the OFF button on the generator set controller.
2. Utility power is connected to the generator set for battery charging and optional AC accessories. Disconnect the power from the generator set.
3. Remove the cover from the air cleaner housing.
4. Remove the air cleaner element.
5. Examine the element and housing for damage. Replace the element and housing if damaged.
6. Tap the element lightly against a flat surface to dislodge loose surface dirt. Do not clean the element in any liquid or use compressed air as these will damage the filter element. Replace the element and pre-cleaner at the intervals shown in the service schedule.
7. Wipe the cover and housing with a clean rag to remove dirt. Make sure the sealing surfaces fit correctly.
8. Replace the air cleaner cover.

5.5 Exhaust System

 WARNING	<p>Carbon Monoxide. Can cause severe nausea, fainting, or death. DO NOT locate the generator set near patios, decks, play areas, or animal shelters.</p>
	



Generator set operation. Carbon monoxide can cause severe nausea, fainting, or death. Carbon monoxide is an odorless, colorless, tasteless, nonirritating gas that can cause death if inhaled for even a short time. Avoid breathing exhaust fumes when working on or near the generator set. Never operate the generator set inside a building. Never operate the generator set where exhaust gas could seep inside or be drawn into a potentially occupied building through windows, air intake vents, or other openings.



Carbon monoxide symptoms. Carbon monoxide can cause severe nausea, fainting, or death. Carbon monoxide is a poisonous gas present in exhaust gases. Carbon monoxide is an odorless, colorless, tasteless, nonirritating gas that can cause death if inhaled for even a short time. Carbon monoxide poisoning symptoms include but are not limited to the following:

- Light-headedness, dizziness
- Physical fatigue, weakness in joints and muscles
- Sleepiness, mental fatigue, inability to concentrate or speak clearly, blurred vision
- Stomachache, vomiting, nausea

If experiencing any of these symptoms and carbon monoxide poisoning is possible, seek fresh air immediately and remain active. Do not sit, lie down, or fall asleep. Alert others to the possibility of carbon monoxide poisoning. Seek medical attention if the condition of affected persons does not improve within minutes of breathing fresh air.

Carbon monoxide detectors. Carbon monoxide can cause severe nausea, fainting, or death. Install carbon monoxide detectors on each level of any building adjacent to the generator set. Locate the detectors to adequately warn the building's occupants of the presence of carbon monoxide. Keep the detectors operational at all times. Periodically test and replace the carbon monoxide detectors according to the manufacturer's instructions.

 CAUTION	<p>Hazardous noise. Can cause hearing loss. Never operate the generator set without a muffler or with a faulty exhaust system.</p>
	

 WARNING	<p>Hot engine and exhaust system. Can cause severe injury or death. Do not work on the generator set until it cools.</p>
	



Servicing the exhaust system. Hot parts can cause severe injury or death. Do not touch hot engine parts. The engine and exhaust system components become extremely hot during operation.

At the interval specified in the service schedule, inspect the exhaust system components (exhaust manifold, exhaust outlet, exhaust line, exhaust clamps, and muffler) for cracks, leaks, and corrosion.

Exhaust System Inspection Points

- Check for corroded or broken metal parts and replace them as needed.
- Check that the exhaust outlet is unobstructed.
- Check the exhaust gas color. If the exhaust is blue or black, contact your local authorized Kohler dealer.
- Visually inspect for exhaust leaks (blowby). Check for carbon or soot residue on exhaust components. Carbon and soot residue indicates an exhaust leak. Seal leaks as needed.
- Check that all covers and doors are undamaged, in place, and locked.
- Check for the installation and operation of carbon monoxide (CO) detectors on each level of any building near the generator set.

5.6 Cooling System

 WARNING	Hot coolant and steam. Can cause severe injury or death. Before removing the pressure cap, stop the generator set and allow it to cool. Then loosen the pressure cap to relieve pressure. Fill system before starting unit.
	

Allow the engine to cool. Release pressure from the cooling system before removing the pressure cap. To release pressure, cover the pressure cap with a thick cloth and then slowly turn the cap counterclockwise to the first stop. Remove the cap after pressure has been completely released and the engine has cooled. Check the coolant level at the tank if the generator set has a coolant recovery tank.

Note:

Block heater damage. The block heater will fail if the energized heater element is not immersed in coolant. Fill the cooling system before turning on the block heater. Run the engine until it is warm and refill the radiator to purge the air from the system before energizing the block heater.

5.6.1 Checking and Filling Coolant

Maintain the coolant level in the coolant overflow bottle between the Hot and Cold markings. See section titled: Service Views, for the coolant overflow bottle location.

Note:

Periodically check the coolant level by removing the radiator's pressure cap. Do not rely solely on the level in the coolant overflow bottle.

Ethylene glycol-based long-life coolant is recommended. Use a coolant mixture of 50% long-life coolant and 50% clean, softened water to inhibit rust/corrosion and prevent freezing. Add fresh coolant until the level is just below the overflow tube opening.

A coolant solution of 50% ethylene glycol-based coolant provides freezing protection to -37°C (-34°F) and overheating protection to 129°C (265°F). A coolant solution with less than 50% ethylene glycol may not provide adequate freezing and overheating protection. A coolant solution with more than 50% ethylene glycol can cause engine or component damage. Do not mix long-life coolant and conventional coolants. **Do not mix different types and/or colors of long life coolants.**

5.6.2 Cooling System Inspection

To prevent generator shutdown or damage because of overheating:

- Keep the cooling air inlets clean and unobstructed
- Inspect the radiator's exterior for obstructions and remove dirt and foreign material with a soft brush or cloth to avoid damaging the radiator fins.
- Check the hoses and connections for leaks and replace any cracked, frayed, or spongy hoses.
- Check the condition and tension of the drive belt.
- Check the rubber seal of the radiator's pressure cap and replace a cracked or deteriorated cap. Remove dirt and other debris from the pressure cap and filler neck. The pressure cap raises the boiling point of the coolant, enabling higher operating temperatures. If the cap leaks, replace it with the same rating type of cap. Find the pressure cap rating in Figure 46.

Item	Rating
Pressure cap	83- 110 kPa (12- 16 psi)

Figure 46 Pressure Cap Rating

5.6.3 Draining Cooling System

The radiator contains a coolant drain valve to drain the cooling system. When draining the coolant, remove the radiator's pressure cap, which will allow the entire system to drain and will prevent air pockets from forming and restricting coolant passage to the block.

1. Press the OFF button on the generator set controller and allow the engine to cool.
2. De-energize the block heater, if equipped.
3. Remove the pressure cap to allow the entire system to drain and prevent air pockets from restricting coolant flow through the engine block.
4. Open the coolant drain valve and allow the system to drain.
5. If the inside of the radiator has mineral deposits or the used coolant contains dirt or grease, flush and clean the cooling system. If the cooling system does not have mineral deposits, refill the cooling system as instructed in Filling Cooling System Section.

5.6.4 Flushing and Cleaning

For optimum protection, drain, flush, and refill the cooling system at the interval listed in the service schedule.

Flushing and Cleaning Procedure

1. Flush the system with clean water.
2. Drain, clean, and flush the coolant overflow bottle.
3. Refill the cooling system as instructed in Filling Cooling System Section.

5.6.5 Filling Cooling System

	Coolant Capacity, L (gal.)
Generator Set	20.8 (5.5)
Generator Set with Block Heater	21.4 (5.7)



Figure 47 Coolant Capacity (approximate)

Note:

Do not add coolant to a hot engine. Adding coolant to a hot engine can cause the cylinder block or cylinder head to crack. Wait until engine has cooled.

1. Close the radiator's coolant drain valve and tighten the hose clamps.
2. Fill the radiator with the recommended coolant mixture of 50% ethylene glycol and 50% clean, softened water to inhibit rust/corrosion and prevent freezing. The coolant capacity is shown in Figure 47.
3. Operate the engine with the radiator cap removed until the thermostat opens and the upper radiator hose becomes hot.
4. Stop the engine and allow it to cool.
5. Add coolant to the radiator to just below the overflow tube on the filler neck. See the Service Views for the overflow tube location.
6. Replace the radiator's pressure cap.
7. Maintain the coolant level in the coolant overflow bottle between the High and Low markings. See the Service Views for the coolant overflow bottle location.
8. Re-energize the block heater, if equipped.

5.7 Spark Plugs

 WARNING	<p>Accidental starting. Can cause severe injury or death.</p> <p>Disconnect the battery cables before working on the generator set. Remove the negative (-) lead first when disconnecting the battery. Reconnect the negative (-) lead last when reconnecting the battery.</p>
	

Disabling the generator set. Accidental starting can cause severe injury or death. Before working on the generator set or equipment connected to the set, disable the generator set as follows: (1) Press the generator set off/reset button to shut down the generator set. (2) Disconnect the power to the battery charger, if equipped. (3) Remove the battery cables, negative (-) lead first. Reconnect the negative (-) lead last when reconnecting the battery. Follow these precautions to prevent the starting of the generator set by the remote start/stop switch.

Service the spark plugs at the interval specified in the service schedule using the following procedure.

1. Press the OFF button on the RDC2 controller.
2. Utility power is connected to the generator set for battery charging and optional AC accessories. Disconnect the power to the generator set.
3. Disconnect the generator set engine starting battery, negative (-) lead first.
4. Remove spark plug wires by grasping the spark plug boot and turning slightly while pulling. Do not pull the wire. Pulling on the wire rather than the boot may damage the wire or terminal.
5. Loosen the spark plug with a ratchet and 5/8-in. spark plug socket with a rubber insert to prevent spark plug damage.
6. Use compressed air to remove dirt from around each spark plug to prevent dirt particles from falling into the combustion chamber.
7. Remove spark plugs, one at a time, and examine. Identify a normal spark plug in good operating condition by observing a light tan or gray deposit on firing tip. See Figure 51 to evaluate engine condition by color/condition of a problem spark plug.
8. Clean spark plugs by wiping them with a rag. File the center electrode to keep it parallel to the side electrode.

Note:

Do not sandblast, wire brush, scrape, or otherwise service spark plugs in poor condition. Obtain a new plug for best results.

9. Check the spark plug gap before installing any spark plug. See Figure 48 and Figure 49. Attain a correct gap when the feeler (or wire) passes between the spark plug electrode. It should pass easily but with some resistance or drag; otherwise adjust as necessary.

Spark Plug Specification	
Spark plug gap	0.76 mm (0.03 in.)
Spark plug torque	27 Nm (20 ft. lbs.)

Figure 48 Recommended Spark Plug Gap

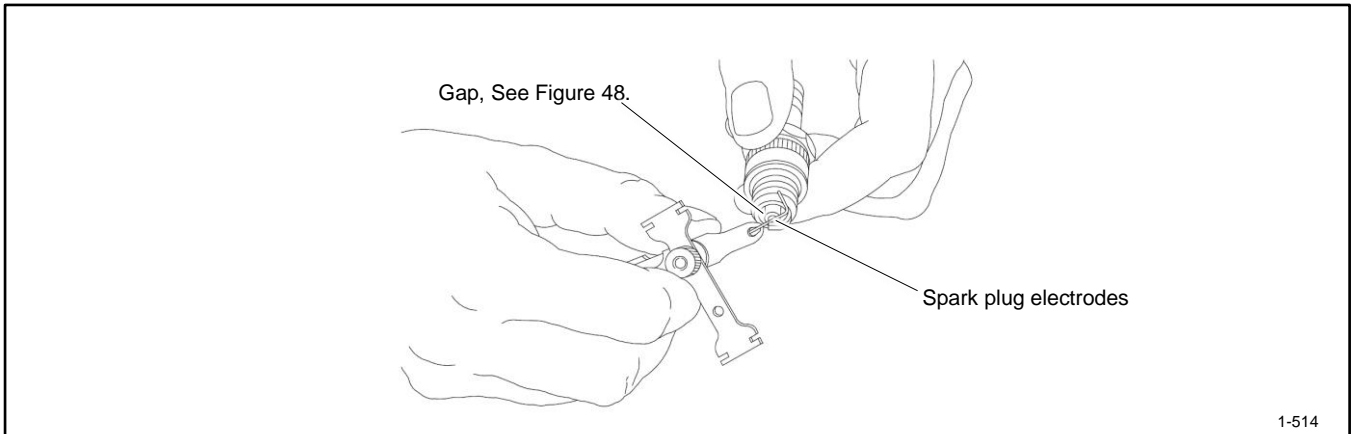

Figure 49 Spark Plug Gap Inspection

10. Use a gapping tool to gently bend the side electrode closer to or farther from the center electrode to set the correct gap. See Figure 50. Position the side electrode directly over the center electrode.

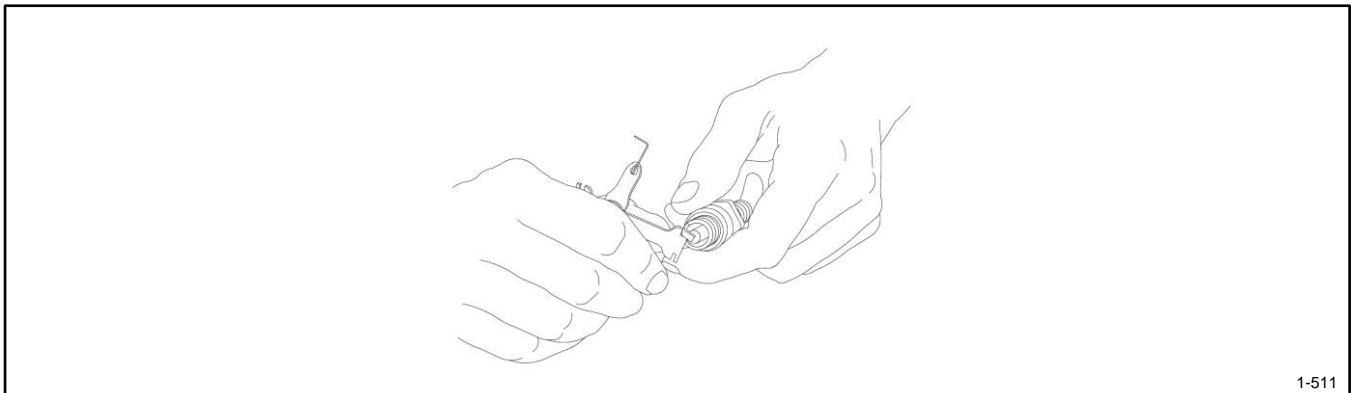

Figure 50 Spark Plug Gap Adjustment



11. Reinstall the spark plug. Do not bump the electrode against the cylinder head. Rotate the spark plug clockwise until you feel resistance.
12. Use a torque wrench to tighten each spark plug to the torque shown in Figure 48. Otherwise, hand-tighten the spark plug until you feel resistance. Then use a ratchet wrench to final tighten an additional 1/4 turn. Do not overtighten, as doing so may strip the threads or alter the electrode gap setting.
13. Check the spark plug wire connector in the boot for accumulated dirt, grease, and other debris, and clean as necessary.
14. Firmly push the spark plug boot onto the spark plug.
15. Reconnect the generator set engine starting battery, negative (-) lead last.
16. Reconnect the power for the battery charger and accessories.

Problem/Condition	Means of Identification	Possible Cause/Solution
Gap-bridged spark plug	Built-up deposits and gap between electrodes closing.	Oil or carbon fouling. Clean and regap the spark plug.
Oil-fouled spark plug	Wet, black deposits on the insulator shell, bore, and electrodes.	Excessive oil entering combustion chamber through worn rings and pistons, excessive clearance between valve guides and stems, or worn or loose bearings. Replace the spark plug.
Carbon-fouled spark plug	Black, dry, fluffy carbon deposits on insulator tips, exposed shell surfaces and electrodes.	Incorrect spark plug, weak ignition, clogged air intake, overrich fuel mixture, or excessive no-load operation. Clean and regap the spark plug.
Lead-fouled spark plug	Dark gray, black, yellow, or tan deposits; or a glazed coating on the insulator tip.	Caused by highly leaded fuel. Replace the spark plug.
Pre-ignition damaged spark plug	Melted electrodes and possibly blistered insulator. Metallic deposits on insulator suggest internal engine damage.	Wrong type of fuel, incorrect timing or advance, too hot a plug, burned valves, or engine overheating. Replace the spark plug.
Overheated spark plug	White or light gray insulator with small black or gray/brown spots with bluish (burned) appearance on electrodes.	Engine overheating, wrong type of fuel, loose spark plugs, too hot a plug, low fuel pressure or incorrect ignition timing. Replace the spark plug.
Worn spark plug	Severely eroded or worn electrodes.	Caused by normal wear and failure to replace spark plug at prescribed interval. Replace the spark plug.

Figure 51 Engine Evaluation Using Spark Plug Condition

5.8 Battery

Consult the battery manufacturer's instructions regarding battery care and maintenance.

 WARNING	<p>Sulfuric acid in batteries. Can cause severe injury or death. Wear protective goggles and clothing. Battery acid may cause blindness and burn skin.</p>
	

Battery electrolyte is a diluted sulfuric acid. Battery acid can cause severe injury or death. Battery acid can cause blindness and burn skin. Always wear splashproof safety goggles, rubber gloves, and boots when servicing the battery. Do not open a sealed battery or mutilate the battery case. If battery acid splashes in the eyes or on the skin, immediately flush the affected area for 15 minutes with large quantities of clean water. Seek immediate medical aid in the case of eye contact. Never add acid to a battery after placing the battery in service, as this may result in hazardous spattering of battery acid.

Battery acid cleanup. Battery acid can cause severe injury or death. Battery acid is electrically conductive and corrosive. Add 500 g (1 lb.) of bicarbonate of soda (baking soda) to a container with 4 L (1 gal.) of water and mix the neutralizing solution. Pour the neutralizing solution on the spilled battery acid and continue to add the neutralizing solution to the spilled battery acid until all evidence of a chemical reaction (foaming) has ceased. Flush the resulting liquid with water and dry the area.

Battery gases. Explosion can cause severe injury or death. Battery gases can cause an explosion. Do not smoke or permit flames or sparks to occur near a battery at any time, particularly when it is charging. Do not dispose of a battery in a fire. To prevent burns and sparks that could cause an explosion, avoid touching the battery terminals with tools or other metal objects. Remove all jewelry before servicing the equipment. Discharge static electricity from your body before touching batteries by first touching a grounded metal surface away from the battery. To avoid sparks, do not disturb the battery charger connections while the battery is charging. Always turn the battery charger off before disconnecting the battery connections. Ventilate the compartments containing batteries to prevent accumulation of explosive gases.

Battery short circuits. Explosion can cause severe injury or death. Short circuits can cause bodily injury and/or equipment damage. Disconnect the battery before generator set installation or maintenance. Remove all jewelry before servicing the equipment. Use tools with insulated handles. Remove the negative (-) lead first when disconnecting the battery. Reconnect the negative (-) lead last when reconnecting the battery. Never connect the negative (-) battery cable to the positive (+) connection terminal of the starter solenoid. Do not test the battery condition by shorting the terminals together.

Refer to this section for general battery information and maintenance. Also consult the battery manufacturer's instructions for battery maintenance.

All generator set models use a negative ground with a 12-volt engine electrical system. Consult the generator set nameplate for the engine electrical system voltage. Consult the generator spec sheet for battery capacity recommendations for replacement purposes. Wiring diagrams provide battery connection information. See Figure 52 for typical battery connections.

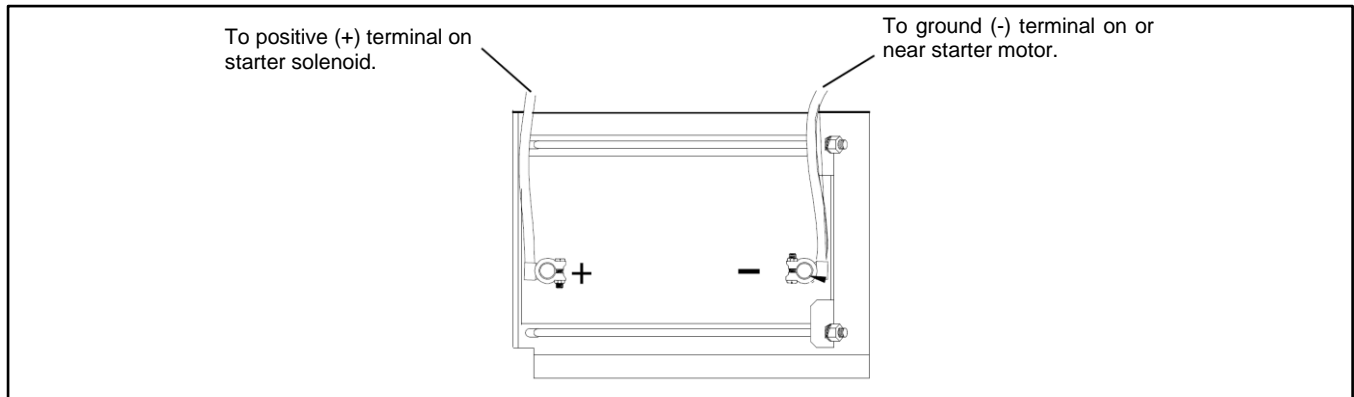

Figure 52 12- Volt Engine Electrical System Single Starter Motor, Typical Battery Connection

Utility power is connected to the generator set for battery charging and optional AC accessories. Disconnect the power to the generator set before servicing the battery. Typically, the power is disconnected by opening a circuit breaker in the customer's electrical distribution box.

Clean the battery and cables and tighten battery terminals using the service schedule recommendations. To prevent corrosion, maintain tight, dry electrical connections at the battery terminals. To remove corrosion from battery terminals, disconnect the cables from the battery and scrub the terminals with a wire brush. Clean the battery and cables with a solution of baking soda and water. After cleaning, flush the battery and cables with clean water and wipe them with a dry, lint-free cloth.

After reconnecting the battery cables, coat the battery terminals with petroleum jelly, silicone grease, or other nonconductive grease.

5.8.1 Checking Electrolyte Level

Check the electrolyte level of batteries with filler caps monthly. Remove filler caps and verify that electrolyte level reaches bottom of filler holes. Refill as necessary with distilled water. DO NOT add fresh electrolyte. Tighten all filler caps. If water is added during freezing temperatures, run the generator set for 20-30 minutes to mix the electrolyte and water to prevent battery damage from freezing.

5.8.2 Checking Specific Gravity

Use a battery hydrometer to check the specific gravity of the electrolyte in each battery cell. While holding the hydrometer vertically, read the number on the glass bulb at the top of the electrolyte level or the number adjacent to the pointer. If the hydrometer used does not have a correction table, use the correction factors in Figure 55. Determine specific gravity and electrolyte temperature of battery cells. Locate temperature in Figure 55 and adjust the specific gravity by the amount shown.

The battery is fully charged if the specific gravity is 1.260 at an electrolyte temperature of 80°F (26.7°C). The difference between specific gravities of each cell should not exceed 0.01. Charge the battery if the specific gravity is below 1.215 at an electrolyte temperature of 80°F (26.7°C). See Figure 53.

Specific Gravity, Corrected to 80°F (26.7°C)	Battery Condition
Below 1.215	Needs charging
1.260	Fully charged

Figure 53 Specific Gravity Interpretation

Some battery testers have four or five beads in the test tube. Draw electrolyte into the tube as performed with the battery hydrometer described previously. Use the manufacturer's instructions. Figure 54 interprets typical test results.

Number of Floating Beads	Battery Condition
5	Overcharged
4	Fully charged
3	Good charge
1 or 2	Low charge
0	Dead battery

Figure 54 Bead-Type Test Interpretation

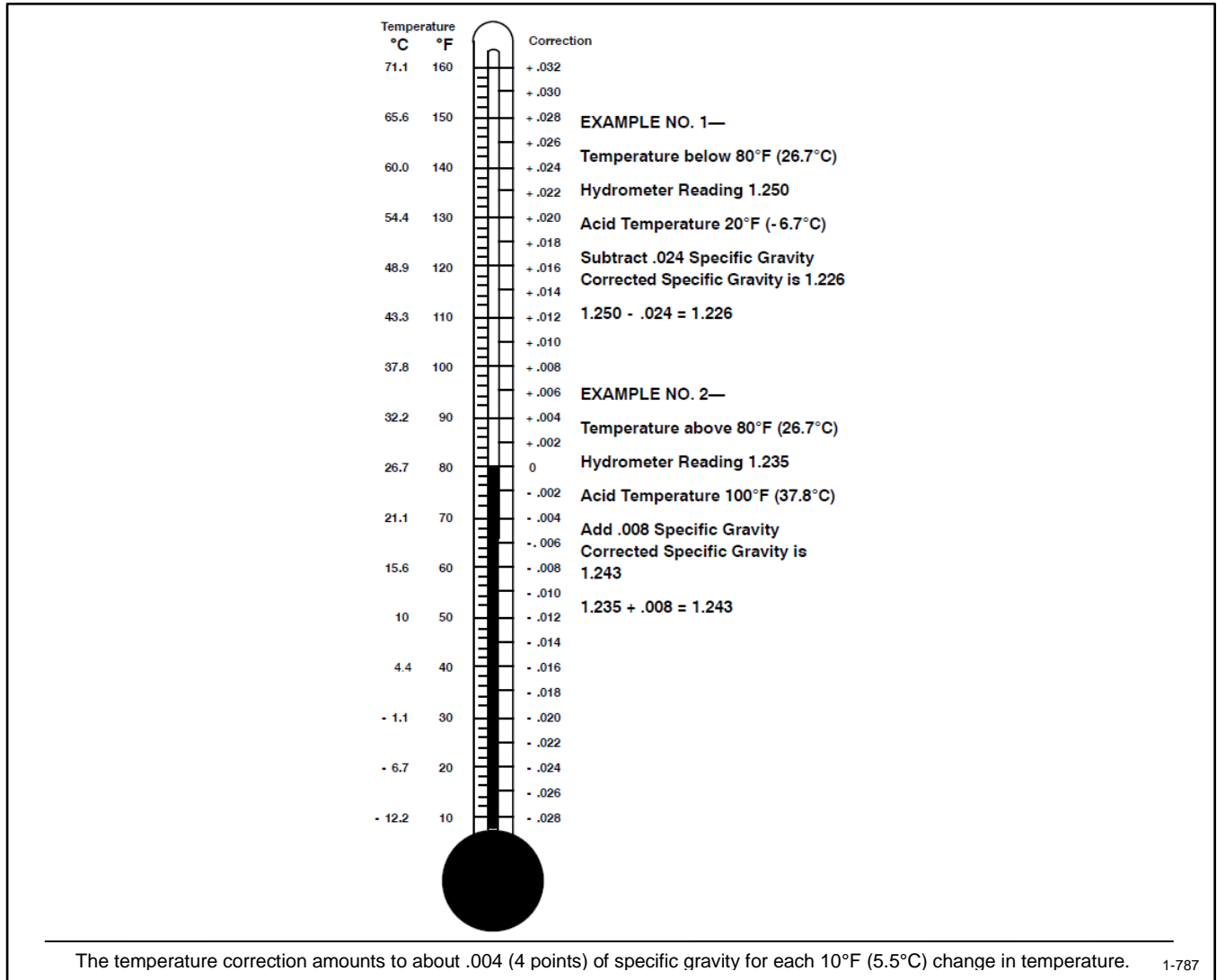





Figure 55 Specific Gravity Temperature Correction

5.9 Storage Procedure

 WARNING	Hot engine and exhaust system. Can cause severe injury or death. Do not work on the generator set until it cools.
	
 	Hazardous voltage. Moving parts. Will cause severe injury or death. Operate the generator set only when all guards and electrical enclosures are in place.

Follow the procedure below when storing your generator set for a long period (3 months or more).

1. Start and run the generator set until it reaches operating temperature or about 15 minutes.
2. Stop the generator set.
3. Change the oil and oil filter.
4. Check the engine coolant protection.

Note:

Use antifreeze capable of withstanding the lowest possible temperatures.

5. Keep spark plugs in their holes or seal spark plug holes with suitable threaded metal plugs.
6. Clean the exterior of the generator set and spread a light film of oil or silicon spray over any exposed surfaces that may be subject to rust or corrosion.
7. Seal the air inlet, exhaust pipe, and fuel tank cap with tape.
8. Disconnect and remove the battery. Place the battery in a warm, dry location for the storage period. Recharge the battery once a month to maintain a full charge.
9. Select a well-ventilated (not humid or dusty) location to store the generator.
10. Cover the entire unit with a dust cover.

Note:

Run the generator set once a month whenever possible.

6.1 Introduction

Use the troubleshooting charts in this section to diagnose and correct common problems. First check for simple causes such as a dead engine starting battery, loose connections, or an open circuit breaker. The charts include a list of common problems, possible causes of the problem, and recommended corrective actions.

If the procedures in this manual do not explain how to correct the problem, contact an authorized Kohler dealer. Maintain a record of repairs and adjustments performed on the equipment. Use the record to help describe the problem and repairs or adjustments made to equipment.

6.2 USB Port

A USB port is located on the front of the controller. Use a USB cable with a mini-B connector to connect the controller to your personal computer (laptop).

Some controller settings can be adjusted using a laptop computer with Kohler® SiteTech™ software. SiteTech software is available to Kohler authorized dealers. See TP-6701, SiteTech™ Software Operation Manual, for more information.

6.3 Fault Messages

The RDC2 controller displays fault messages to aid in troubleshooting. Fault messages, descriptions, and recommended checks are listed in previous sections. See the Table of Contents for the sections about faults and other messages.

Identify and correct the cause of the fault condition. Then reset the controller after a fault shutdown.

6.4 Circuit Protection

If the generator set circuit breaker trips or the fuses blow repeatedly, contact an authorized Kohler dealer for service.

6.4.1 Load Circuit Breaker

The load circuit breaker interrupts the generator output in the event of a fault in the wiring between the generator and the load. If the circuit breaker trips, reduce the load and switch the breaker back to the ON position. Refer to the service views for the location of the circuit breaker.

6.4.2 Fuses

Always identify and correct the cause of a blown fuse before restarting the generator set. Refer to the General Troubleshooting Chart for conditions that may indicate a blown fuse. Obtain replacement parts and service from an authorized Kohler dealer.

Fan Fuses. Three 30-amp fan fuses are located in the fan fuse and relay box. See the Service Views Section for location.

6.4.3 Controller Internal Circuit Protection

The controller is equipped with internal circuit protection. Press OFF to reset.

6.5 Generator Set Troubleshooting

Figure 56 contains generator set troubleshooting, diagnostic, and repair information. Check for loose connections before replacing parts.

Note:

Read all safety precautions at the beginning of this publication before performing any work on the generator set.

Problem	Possible Cause	Corrective Action
The generator set does not crank.	Battery weak or dead.	Recharge or replace the battery.
	Battery connections reversed or poor.	Check the connections.
	Blown fuse(s).	Replace the fuse. Contact an authorized Kohler dealer for service if fuse blows repeatedly.
	Generator set is OFF.	Press the RUN button to start the engine or press AUTO to allow remote starting.
The generator set cranks but does not start, starts hard, lacks power, or operates erratically.	Air cleaner clogged.	Clean and/or replace the air cleaner element.
	Battery weak or dead.	Recharge or replace the battery.
	Battery connection poor.	Clean and tighten the battery connections.
	Spark plug wire connection loose.	Check the spark plug wires.
	Low oil pressure shutdown.	Check for oil leaks. Check the oil level and add oil if necessary.
	Fuel pressure insufficient.	Check the fuel supply and valves.
	Engine malfunction.	Contact an authorized Kohler dealer.
No AC output.	AC circuit breaker in the OFF position.	Place the circuit breaker in the ON position.
	AC circuit breaker tripping because of overload.	Reduce the load on the generator set by unplugging non-essential appliances.
	AC circuit breaker tripping because of short circuit.	Contact an authorized Kohler dealer for service.
Low output or excessive drop in voltage.	Generator set overloaded.	Reduce the load by unplugging non-essential appliances.
Generator set stops suddenly.	Low oil pressure shutdown.	Check for oil leaks. Check the oil level and add oil if necessary.
	Out of fuel.	Check fuel supply.
	Overcrank shutdown.	Reset the controller. If the overcrank fault occurs again, contact an authorized Kohler dealer.
	Blown fuse(s).	Replace the fuse. If the fuse blows again, contact an authorized Kohler dealer.
	Overspeed shutdown.	Reset the controller. If the overspeed fault occurs again, contact an authorized Kohler dealer.
	Generator set is OFF.	Press the RUN button to start the engine or press AUTO to allow remote starting.
	Remote stop command received from a remote switch, ATS, or OnCue®.	Check the remote switch position.
Engine malfunction.	Contact an authorized Kohler dealer.	
Fans run after engine shuts down.	The fans continue to run for 2 minutes after the engine shuts down to evacuate the engine compartment.	None.

Figure 56 General Troubleshooting Chart

6.6 Controller Troubleshooting

Figure 57 contains basic troubleshooting information for the RDC2 controller.

Problem	Possible Cause	Corrective Action
Controller LCD display is off.	Low or no battery voltage.	Check connections. Check generator set battery.
Controller display backlight is off.	Backlight turns off after about 1 minute with no activity.	Backlight will turn on when a button is pressed or the generator set starts.
Loss of communication to accessory modules	Bad connections.	Check wiring and connections. Verify that cable size and length of run comply with the instructions in the Installation manual.
	Low or no battery voltage.	Check battery connections. Check generator set battery.
Load management relays do not operate.	Bad connections.	Check wiring and connections. Verify that cable size and length of run comply with the instructions in the Installation manual.
	Low or no battery voltage.	Check battery connections. Check generator set battery.
Date is flashing.	Controller power was disconnected and then reconnected.	Check battery connections. Check utility power connection for the built-in battery charger. Reset the time, date, and exercise schedule.

Figure 57 RDC2 Troubleshooting Chart

Notes

Appendix A. Abbreviations

A, amp	ampere	blk. htr.	block heater	DAC	digital to analog converter
ABDC	after bottom dead center	BMEP	brake mean effective pressure	dB	decibel
AC	alternating current	bps	bits per second	dB(A)	decibel (A weighted)
A/D	analog to digital	br.	Brass	DC	direct current
ADC	advanced digital control; analog to digital converter	BTDC	before top dead center	DCR	direct current resistance
adj.	adjust, adjustment	Btu	British thermal unit	DEF	diesel exhaust fluid
ADV	advertising dimensional drawing	Btu/min.	British thermal units per minute	deg., °	degree
AGM	absorbent glass mat	C	Celsius, centigrade	dept.	department
Ah	amp-hour	cal.	Calorie	dia.	Diameter
AHWT	anticipatory high water temperature	CAN	controller area network	DI/EO	dual inlet/end outlet
AISI	American Iron and Steel Institute	CARB	California Air Resources Board	DIN	Deutsches Institut fur Normung e. V. (also Deutsche Industrie Normenausschuss)
ALOP	anticipatory low oil pressure	CAT5	Category 5 (network cable)	DIP	dual inline package
alt.	alternator	CB	circuit breaker	DPDT	double-pole, double-throw
Al	aluminum	CC	crank cycle	DPST	double-pole, single-throw
ANSI	American National Standards Institute (formerly American Standards Association, ASA)	cc	cubic centimeter	DS	disconnect switch
AO	anticipatory only	CCA	cold cranking amps	DVR	digital voltage regulator
APDC	Air Pollution Control District	ccw.	Counterclockwise	E2PROM, EEPROM	electrically-erasable programmable read-only memory
API	American Petroleum Institute	CEC	Canadian Electrical Code	E, emer.	emergency (power source)
approx.	approximate, approximately	cert.	certificate, certification, certified	EATS	Exhaust Aftertreatment System
APU	Auxiliary Power Unit	cfh	cubic feet per hour	ECM	electronic control module, engine control module
AQMD	Air Quality Management District	cfm	cubic feet per minute	EDI	electronic data interchange
AR	as required, as requested	CG	center of gravity	EFR	emergency frequency relay
AS	as supplied, as stated, as suggested	CID	cubic inch displacement	e.g.	for example (exempli gratia)
ASE	American Society of Engineers	CL	centerline	EG	electronic governor
ASME	American Society of Mechanical Engineers	cm	centimeter	EGSA	Electrical Generating Systems Association
assy.	Assembly	CMOS	complementary metal oxide substrate (semiconductor)	EIA	Electronic Industries Association
ASTM	American Society for Testing Materials	com	communications (port)	EI/EO	end inlet/end outlet
ATDC	after top dead center	coml	commercial	EMI	electromagnetic interference
ATS	automatic transfer switch	Coml/Rec	Commercial/Recreational	emiss.	Emission
auto.	Automatic	conn.	Connection	eng.	Engine
aux.	auxiliary	cont.	continued	EPA	Environmental Protection Agency
avg.	average	CPVC	chlorinated polyvinyl chloride	EPS	emergency power system
AVR	automatic voltage regulator	crit.	Critical	ER	emergency relay
AWG	American Wire Gauge	CRM	Common Rail Manifold	ES	engineering special, engineered special
AWM	appliance wiring material	CSA	Canadian Standards Association		
bat.	Battery	CT	current transformer	ESD	electrostatic discharge
BBDC	before bottom dead center	Cu	copper	est.	estimated
BC	battery charger, battery charging	cUL	Canadian Underwriter's Laboratories	E-Stop	emergency stop
BCA	battery charging alternator	cu. in.	cubic inch	etc.	et cetera (and so forth)
BCI	Battery Council International	cw.	Clockwise	exh.	exhaust
BDC	before dead center	CWC	city water-cooled	ext.	external
BHP	brake horsepower	cyl.	Cylinder	F	Fahrenheit, female
blk.	black (paint color), block (engine)	D/A	digital to analog	FDS	Fluid Dosing System

FHM	flat head machine (screw)	in.	inch	Lpm	liters per minute
fl. oz.	fluid ounce	in. H ₂ O	inches of water	LOP	low oil pressure
flex.	flexible	in. Hg	inches of mercury	LP	liquefied petroleum
freq.	frequency	in. Lb.	inch pounds	LPG	liquefied petroleum gas
FS	full scale	Inc.	incorporated	LS	left side
ft.	foot, feet	ind.	Industrial	L _{wa}	sound power level, A weighted
ft. lb.	foot pounds (torque)	int.	internal	LWL	low water level
ft./min.	feet per minute	int./ext.	internal/external	LWT	low water temperature
ftp	file transfer protocol	I/O	input/output	m	meter, milli (1/1000)
g	gram	IP	internet protocol	M	mega (10 ⁶ when used with SI units), male
ga.	gauge (meters, wire size)	ISO	International Organization for Standardization	m ³	cubic meter
gal.	gallon	J	joule	m ³ /hr.	cubic meters per hour
gen.	generator	JIS	Japanese Industry Standard	m ³ /min.	cubic meters per minute
genset	generator set	k	kilo (1000)	mA	milliampere
GFI	ground fault interrupter	K	kelvin	man.	manual
GND, ⊕	ground	kA	kiloampere	max.	maximum
gov.	governor	KB	kilobyte (2 ¹⁰ bytes)	MB	megabyte (2 ²⁰ bytes)
gph	gallons per hour	KBus	Kohler communication protocol	MCCB	molded-case circuit breaker
gpm	gallons per minute	kg	kilogram	MCM	one thousand circular mils
gr.	grade, gross	kg/cm ²	kilograms per square centimeter	meggar	megohmmeter
GRD	equipment ground	kgm	kilogram-meter	MHz	megahertz
gr. wt.	gross weight	kg/m ³	kilograms per cubic meter	mi.	mile
H x W x D	height by width by depth	kHz	kilohertz	mil	one one-thousandth of an inch
HC	hex cap	kJ	kilojoule	min.	minimum, minute
HCHT	high cylinder head temperature	km	kilometer	misc.	miscellaneous
HD	heavy duty	kOhm, kΩ	kilo-ohm	MJ	megajoule
HET	high exhaust temp., high engine temp.	kPa	kilopascal	mJ	millijoule
hex	hexagon	kph	kilometers per hour	mm	millimeter
Hg	mercury (element)	kV	kilovolt	mOhm, mΩ	milliohm
HH	hex head	kVA	kilovolt ampere	MOhm, MΩ	megohm
HHC	hex head cap	kVAR	kilovolt ampere reactive	MOV	metal oxide varistor
HP	horsepower	kW	kilowatt	MPa	megapascal
hr.	hour	kWh	kilowatt-hour	mpg	miles per gallon
HS	heat shrink	kWm	kilowatt mechanical	mph	miles per hour
hsg.	Housing	kWth	kilowatt-thermal	MS	military standard
HVAC	heating, ventilation, and air conditioning	L	liter	ms	millisecond
HWT	high water temperature	LAN	local area network	m/sec.	meters per second
Hz	hertz (cycles per second)	L x W x H	length by width by height	mtg.	mounting
IBC	International Building Code	lb.	pound, pounds	MTU	Motoren-und Turbinen-Union
IC	integrated circuit	lbm/ft ³	pounds mass per cubic feet	MW	megawatt
ID	inside diameter, identification	LCB	line circuit breaker	mW	milliwatt
IEC	International Electrotechnical Commission	LCD	liquid crystal display	μF	microfarad
IEEE	Institute of Electrical and Electronics Engineers	LED	light emitting diode	μF	microfarad
IMS	improved motor starting	Lph	liters per hour		

N, norm.	normal (power source)	PMG	permanent magnet generator	SCR	silicon controlled rectifier (electrical), selective catalytic reduction (exhaust emissions)
NA	not available, not applicable	pot	potentiometer, potential	s, sec.	second
nat. gas	natural gas	ppm	parts per million	SI	<i>Systeme international d'unites</i> , International System of Units
NBS	National Bureau of Standards	PROM	programmable read-only memory	SI/EO	side in/end out
NC	normally closed	psi	pounds per square inch	sil.	Silencer
NEC	National Electrical Code	psig	pounds per square inch gauge	SMTP	simple mail transfer protocol
NEMA	National Electrical Manufacturers Association	pt.	pint	SN	serial number
NiCd	nickel cadmium	PTC	positive temperature coefficient	SNMP	simple network management protocol
NFPA	National Fire Protection Association	PTO	power takeoff	SPDT	single-pole, double-throw
Nm	newton meter	PVC	polyvinyl chloride	SPST	single-pole, single-throw
NO	normally open	PVC	polyvinyl chloride	spec	specification
no., nos.	number, numbers	PWM	pulse width modulated, pulse width modulation	specs	specification(s)
NPS	National Pipe, Straight	qt.	quart, quarts	sq.	square
NPSC	National Pipe, Straight-coupling	qty.	quantity	sq. cm	square centimeter
NPT	National Standard taper pipe thread per general use	R	replacement (emergency) power source	sq. in.	square inch
NPTF	National Pipe, Taper-Fine	rad.	radiator, radius	SMS	short message service
NR	not required, normal relay	RAM	random access memory	SS	stainless steel
Ns	nanosecond	RDO	relay driver output	std.	standard
OC	overcrank	ref.	reference	stl.	Steel
OD	outside diameter	rem.	Remote	tach.	Tachometer
OEM	original equipment manufacturer	Res/Com	Residential/Commercial	TB	terminal block
OF	overfrequency	RFI	radio frequency interference	TCP	transmission control protocol
opt.	option, optional	RH	round head	TD	time delay
OS	oversize, overspeed	RHM	round head machine (screw)	TDC	top dead center
OSHA	Occupational Safety and Health Administration	rly.	Relay	TDEC	time delay engine cooldown
OSHPD	Office of Statewide Health Planning and Development (California)	rms	root mean square	TDEN	time delay emergency to normal
OV	overvoltage	rnd.	Round	TDES	time delay engine start
oz.	ounce	RO	read only	TDNE	time delay normal to emergency
p., pp.	page, pages	ROM	read only memory	TDOE	time delay off to emergency
PC	personal computer	rot.	rotate, rotating	TDON	time delay off to normal
PCB	printed circuit board	rpm	revolutions per minute	temp.	temperature
pF	picofarad	RS	right side	term.	Terminal
PF	power factor	RTDs	resistance temperature detectors	THD	total harmonic distortion
ph., ø	phase	RTU	remote terminal unit	TIF	telephone influence factor
PHC	Phillips® head Crimptiter (screw)	RTV	room temperature vulcanization	tol.	Tolerance
PHH	Phillips® hex head (screw)	RW	read/write	turbo.	Turbocharger
PHM	pan head machine (screw)	SAE	Society of Automotive Engineers	typ.	typical (same in multiple locations)
PLC	programmable logic control	scfm	standard cubic feet per minute	UF	underfrequency

UHF	ultrahigh frequency
UIF	user interface
UL	Underwriter's Laboratories, Inc.
UNC	unified coarse thread (was NC)
UNF	unified fine thread (was NF)
univ.	universal
URL	uniform resource locator (web address)
US	undersize, underspeed
UV	ultraviolet, undervoltage
V	volt
VAC	volts alternating current
VAR	voltampere reactive
VDC	volts direct current
VFD	vacuum fluorescent display
VGA	video graphics adapter
VHF	very high frequency
W	watt
WCR	withstand and closing rating
w/	with
WO	write only
w/o	without
wt.	weight
xfr	transformer

TP-7102 3/23f

Original Instructions (English)

© 2018 Kohler Co. All rights reserved.

KOHLER®

KOHLER CO. Kohler, Wisconsin 53044
Phone 920-457-4441, Fax 920-459-1646
For the nearest sales/service outlet in the
US and Canada, phone 1-800-544-2444
KOHLERPower.com